

# REACTOR™

312062E rev.k

**Hydraulic, Heated, Plural Component Proportioner**  
***For spraying polyurethane foam and polyurea coatings.***  
***Not for use in explosive atmospheres.***

U.S. Patent Pending



### Important Safety Instructions

Read all warnings and instructions in this manual. Save these instructions.

See page 3 for model information, including maximum working pressure and approvals.

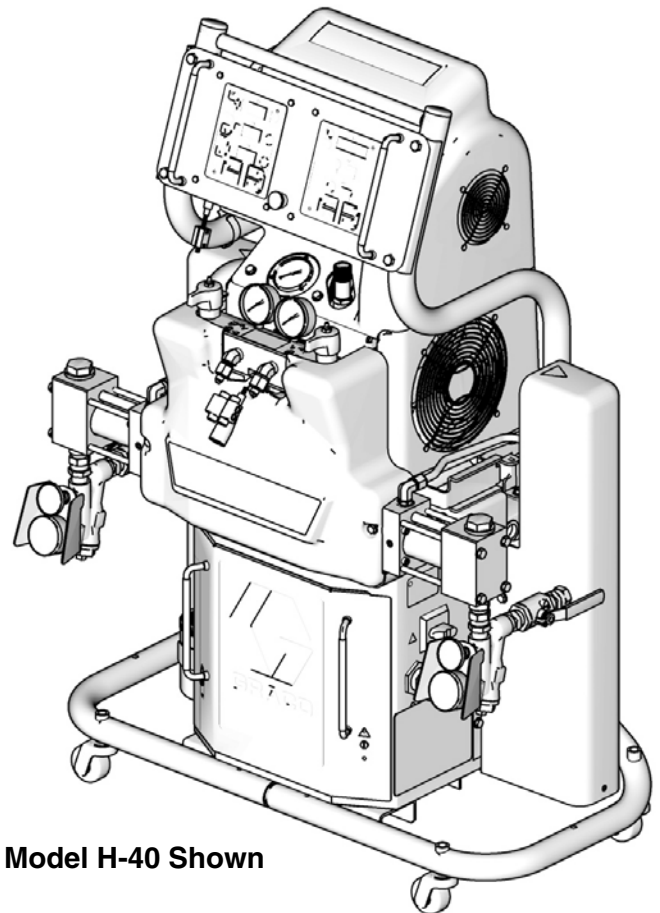

Model H-40 Shown

T9830a

CE



9902471

Conforms to ANSI/UL  
Std. 499 Certified to  
CAN/CSA Std.  
C22.2 No. 88

# Contents

<b>Models</b> .....	<b>3</b>	<b>Fluid Circulation</b> .....	<b>36</b>
<b>Supplied Manuals</b> .....	<b>5</b>	Circulation Through Reactor .....	36
<b>Related Manuals</b> .....	<b>6</b>	Circulation Through Gun Manifold .....	37
<b>Warnings</b> .....	<b>7</b>	<b>Diagnostic Codes</b> .....	<b>38</b>
<b>Isocyanate Hazard</b> .....	<b>10</b>	Temperature Control Diagnostic Codes	38
<b>Material Self-ignition</b> .....	<b>10</b>	Motor Control Diagnostic Codes .....	39
<b>Moisture Sensitivity of Isocyanates</b> .....	<b>10</b>	<b>Maintenance</b> .....	<b>40</b>
<b>Keep Components A and B Separate</b> ..	<b>11</b>	Fluid Inlet Strainer Screen .....	41
<b>Foam Resins with</b>		Pump Lubrication System .....	42
<b>245 fa Blowing Agents</b> .....	<b>11</b>	<b>Flushing</b> .....	<b>43</b>
<b>Changing Materials</b> .....	<b>11</b>	<b>Dimensions</b> .....	<b>44</b>
<b>Typical Installation, with circulation</b> ..	<b>12</b>	<b>Technical Data</b> .....	<b>45</b>
<b>Typical Installation, without circulation</b>	<b>13</b>	<b>Performance Charts</b> .....	<b>46</b>
<b>Component Identification</b> .....	<b>14</b>	<b>Graco Standard Warranty</b> .....	<b>48</b>
<b>Temperature Controls and Indicators</b> ..	<b>16</b>	<b>Graco Information</b> .....	<b>48</b>
Main Power Switch .....	16		
Red Stop Button .....	16		
Actual Temperature Key/LED .....	16		
Target Temperature Key/LED .....	17		
Temperature Scale Keys/LEDs .....	17		
Heater Zone On/Off Keys/LEDs .....	17		
Temperature Arrow Keys .....	17		
Temperature Displays .....	17		
Circuit Breakers .....	18		
<b>Motor Controls and Indicators</b> .....	<b>19</b>		
Motor ON/OFF Key/LED .....	19		
PARK Key/LED .....	19		
PSI/BAR Keys/LEDs .....	19		
Pressure Key/LED .....	19		
Cycle Count Key/LED .....	20		
Hydraulic Pressure Control Knob .....	20		
Motor Control Arrow Keys .....	20		
<b>Spray Adjustments</b> .....	<b>20</b>		
<b>Setup</b> .....	<b>21</b>		
<b>Startup</b> .....	<b>27</b>		
<b>Spraying</b> .....	<b>31</b>		
<b>Standby</b> .....	<b>33</b>		
<b>Shutdown</b> .....	<b>34</b>		
<b>Pressure Relief Procedure</b> .....	<b>35</b>		

# Models

## H-25 SERIES

Part, Series	Full Load Peak Amps* Per Phase	Voltage (phase)	System Watts†	Primary Heater Watts	Max Flow Rate◆ lb/min (kg/min)	Approximate Output per Cycle (A+B) gal. (liter)	Hydraulic Pressure Ratio	Maximum Fluid Working Pressure psi (MPa, bar)
255400, E	69	230V (1)	15,960	8,000	22 (10)	0.063 (0.24)	1.91:1	2000 (13.8, 138)
255401, E	46	230V (3)	15,960	8,000	22 (10)	0.063 (0.24)	1.91:1	2000 (13.8, 138)
255402, E	35	400V (3)	15,960	8,000	22 (10)	0.063 (0.24)	1.91:1	2000 (13.8, 138)
255406, E	100	230V (1)	23,260	15,300	22 (10)	0.063 (0.24)	1.91:1	2000 (13.8, 138)
255407, E	59	230V (3)	23,260	15,300	22 (10)	0.063 (0.24)	1.91:1	2000 (13.8, 138)
255408, E	35	400V (3)	23,260	15,300	22 (10)	0.063 (0.24)	1.91:1	2000 (13.8, 138)

## H-40 SERIES

Part, Series	Full Load Peak Amps* Per Phase	Voltage (phase)	System Watts†	Primary Heater Watts	Max Flow Rate◆ lb/min (kg/min)	Approximate Output per Cycle (A+B) gal. (liter)	Hydraulic Pressure Ratio	Maximum Fluid Working Pressure psi (MPa, bar)
★253400, E	100	230V (1)	23,100	12,000	45 (20)	0.063 (0.24)	1.91:1	2000 (13.8, 138)
253401, E	71	230V (3)	26,600	15,300	45 (20)	0.063 (0.24)	1.91:1	2000 (13.8, 138)
253402, E	41	400V (3)	26,600	15,300	45 (20)	0.063 (0.24)	1.91:1	2000 (13.8, 138)
253407, E	95	230V (3)	31,700	20,400	45 (20)	0.063 (0.24)	1.91:1	2000 (13.8, 138)
253408, E	52	400V (3)	31,700	20,400	45 (20)	0.063 (0.24)	1.91:1	2000 (13.8, 138)

## H-50 SERIES

Part, Series	Full Load Peak Amps* Per Phase	Voltage (phase)	System Watts†	Primary Heater Watts	Max Flow Rate◆ lb/min (kg/min)	Approximate Output per Cycle (A+B) gal. (liter)	Hydraulic Pressure Ratio	Maximum Fluid Working Pressure psi (MPa, bar)
★253725, E	100	230V (1)	23,100	12,000	52 (24)	0.073 (0.28)	1.64:1	1700 (11.7, 117)
253726, E	71	230V (3)	26,600	15,300	52 (24)	0.073 (0.28)	1.64:1	2000 (13.8, 138)
253727, E	41	400V (3)	26,600	15,300	52 (24)	0.073 (0.28)	1.64:1	2000 (13.8, 138)
256505, E	95	230V (3)	31,700	20,400	52 (24)	0.073 (0.28)	1.64:1	2000 (13.8, 138)
256506, E	52	400V (3)	31,700	20,400	52 (24)	0.073 (0.28)	1.64:1	2000 (13.8, 138)

**H-XP2 SERIES**

Part, Series	Full Load Peak Amps* Per Phase	Voltage (phase)	System Watts†	Primary Heater Watts	Max Flow Rate◆ gpm (lpm)	Approximate Output per Cycle (A+B) gal. (liter)	Hydraulic Pressure Ratio	Maximum Fluid Working Pressure psi (MPa, bar)
255403, E	100	230V (1)	23,260	15,300	1.5 (5.7)	0.042 (0.16)	2.79:1	3500 (24.1, 241)
255404, E	59	230V (3)	23,260	15,300	1.5 (5.7)	0.042 (0.16)	2.79:1	3500 (24.1, 241)
255405, E	35	400V (3)	23,260	15,300	1.5 (5.7)	0.042 (0.16)	2.79:1	3500 (24.1, 241)

**H-XP3 SERIES**

Part, Series	Full Load Peak Amps* Per Phase	Voltage (phase)	System Watts†	Primary Heater Watts	Max Flow Rate◆ gpm (lpm)	Approximate Output per Cycle (A+B) gal. (liter)	Hydraulic Pressure Ratio	Maximum Fluid Working Pressure psi (MPa, bar)
★253403, E	100	230V (1)	23,100	12,000	2.8 (10.6)	0.042 (0.16)	2.79:1	3500 (24.1, 241)
253404, E	95	230V (3)	31,700	20,400	2.8 (10.6)	0.042 (0.16)	2.79:1	3500 (24.1, 241)
253405, E	52	400V (3)	31,700	20,400	2.8 (10.6)	0.042 (0.16)	2.79:1	3500 (24.1, 241)

\* Full load amps with all devices operating at maximum capabilities. Fuse requirements at various flow rates and mix chamber sizes may be less.

† Total system watts, based on maximum hose length for each unit:

- Parts 255400 through 255408, 310 ft (94.6 m) maximum heated hose length, including whip hose.
- Parts 253400 through 253408, 253725 through 253727, 256505, and 256506, 410 ft (125 m) maximum heated hose length, including whip hose.

◆ Maximum flow rate given for 60 Hz operation. For 50 Hz operation, maximum flow rate is 5/6 of 60 Hz maximum flow.

★CE approval does not apply.

## Supplied Manuals

The following manuals are shipped with the Reactor™ Proportioner. Refer to these manuals for detailed equipment information.

Order Part 15M334 for a compact disk of Reactor manuals translated in several languages.

Manuals are also available at [www.graco.com](http://www.graco.com).

<b>Reactor Hydraulic Proportioner</b>	
<b>Part</b>	<b>Description</b>
312063	Reactor Hydraulic Proportioner, Repair-Parts Manual (English)
<b>Reactor Electrical Diagrams</b>	
<b>Part</b>	<b>Description</b>
312064	Reactor Hydraulic Proportioner, Electrical Diagrams (English)
<b>Proportioning Pump</b>	
<b>Part</b>	<b>Description</b>
312068	Proportioning Pump Repair-Parts Manual (English)

## Translations

The Reactor Operation manual is available in the following languages. See the following chart for specific languages and corresponding part numbers.

<b>Part</b>	<b>Language</b>
312062	English
312419	Chinese
312420	Dutch
312421	French
312422	German
312423	Italian
312424	Japanese
312425	Korean
312426	Russian
312427	Spanish

## Related Manuals

The following manuals are for accessories used with the Reactor™.







Order Part 15M334 for a compact disk of Reactor manuals translated in several languages.

Feed Pump Kits	
Part	Description
309815	Instruction-Parts Manual (English)
Air Supply Kit	
Part	Description
309827	Instruction-Parts Manual (English) for Feed Pump Air Supply Kit
Circulation and Return Tube Kits	
Part	Description
309852	Instruction-Parts Manual (English)
Heated Hose	
Part	Description
309572	Instruction-Parts Manual (English)
Circulation Kit	
Part	Description
309818	Instruction-Parts Manual (English)
Circulation Valve Kit	
Part	Description
312070	Instruction-Parts Manual (English)

Data Reporting Kit	
Part	Description
309867	Instruction-Parts Manual (English)
Rupture Disk Assembly Kit	
Part	Description
309969	Instruction-Parts Manual (English)
Proportioning Pump Repair Kits	
Part	Description
312071	Seal Kits Instruction-Parts Manual (English)

# Warnings

The following warnings are for the setup, use, grounding, maintenance, and repair of this equipment. The exclamation point symbol alerts you to a general warning and the hazard symbol refers to procedure-specific risk. Refer back to these warnings. Additional, product-specific warnings may be found throughout the body of this manual where applicable.

 <b>WARNING</b>	
	<p><b>ELECTRIC SHOCK HAZARD</b></p> <p>This equipment must be grounded. Improper grounding, setup, or usage of the system can cause electric shock.</p> <ul style="list-style-type: none"> <li>• Turn off and disconnect power at main switch before disconnecting any cables and before servicing equipment.</li> <li>• Connect only to grounded power source.</li> <li>• All electrical wiring must be done by a qualified electrician and comply with all local codes and regulations.</li> </ul>
	<p><b>TOXIC FLUID OR FUMES HAZARD</b></p> <p>Toxic fluids or fumes can cause serious injury or death if splashed in the eyes or on skin, inhaled, or swallowed.</p> <ul style="list-style-type: none"> <li>• Read MSDS's to know the specific hazards of the fluids you are using.</li> <li>• Store hazardous fluid in approved containers, and dispose of it according to applicable guidelines.</li> <li>• Always wear impervious gloves when spraying or cleaning equipment.</li> </ul>
	<p><b>PERSONAL PROTECTIVE EQUIPMENT</b></p> <p>You must wear appropriate protective equipment when operating, servicing, or when in the operating area of the equipment to help protect you from serious injury, including eye injury, inhalation of toxic fumes, burns, and hearing loss. This equipment includes but is not limited to:</p> <ul style="list-style-type: none"> <li>• Protective eyewear</li> <li>• Clothing and respirator as recommended by the fluid and solvent manufacturer</li> <li>• Gloves</li> <li>• Hearing protection</li> </ul>
 	<p><b>SKIN INJECTION HAZARD</b></p> <p>High-pressure fluid from gun, hose leaks, or ruptured components will pierce skin. This may look like just a cut, but it is a serious injury that can result in amputation. <b>Get immediate surgical treatment.</b></p> <ul style="list-style-type: none"> <li>• Do not point gun at anyone or at any part of the body.</li> <li>• Do not put your hand over the spray tip.</li> <li>• Do not stop or deflect leaks with your hand, body, glove, or rag.</li> <li>• Do not spray without tip guard and trigger guard installed.</li> <li>• Engage trigger lock when not spraying.</li> <li>• Follow <b>Pressure Relief Procedure</b> in this manual, when you stop spraying and before cleaning, checking, or servicing equipment.</li> </ul>

**WARNING**

**FIRE AND EXPLOSION HAZARD**

Flammable fumes, such as solvent and paint fumes, in work area can ignite or explode. To help prevent fire and explosion:

- Use and clean equipment only in well ventilated area.
- Eliminate all ignition sources; such as pilot lights, cigarettes, portable electric lamps, and plastic drop cloths (potential static arc).
- Keep work area free of debris, including solvent, rags and gasoline.
- Do not plug or unplug power cords or turn lights on or off when flammable fumes are present.
- Ground equipment, personnel, object being sprayed, and conductive objects in work area. See **Grounding** instructions.
- Use only Graco grounded hoses.
- Check gun resistance daily.
- If there is static sparking or you feel a shock, **stop operation immediately**. Do not use equipment until you identify and correct the problem.
- Do not flush with gun electrostatics on. Do not turn on electrostatics until all solvent is removed from system.
- Keep a working fire extinguisher in the work area.

**PRESSURIZED ALUMINUM PARTS HAZARD**

Do not use 1,1,1-trichloroethane, methylene chloride, other halogenated hydrocarbon solvents or fluids containing such solvents in pressurized aluminum equipment. Such use can cause serious chemical reaction and equipment rupture, and result in death, serious injury, and property damage.



 **WARNING**



**EQUIPMENT MISUSE HAZARD**

Misuse can cause death or serious injury.

- This equipment is for professional use only.
- Do not leave the work area while the equipment is energized or under pressure. Turn off all equipment and follow the **Pressure Relief Procedure** in this manual when the equipment is not in use.
- Do not operate the unit when fatigued or under the influence of drugs or alcohol.
- Do not exceed the maximum working pressure or temperature rating of the lowest rated system component. See **Technical Data** in all equipment manuals.
- Use fluids and solvents that are compatible with equipment wetted parts. See **Technical Data** in all equipment manuals. Read fluid and solvent manufacturer's warnings. For complete information about your material, request MSDS forms from distributor or retailer.
- Check equipment daily. Repair or replace worn or damaged parts immediately with genuine manufacturer's replacement parts only.
- Do not alter or modify equipment.
- Use equipment only for its intended purpose. Call your distributor for information.
- Route hoses and cables away from traffic areas, sharp edges, moving parts, and hot surfaces.
- Do not kink or over bend hoses or use hoses to pull equipment.
- Keep children and animals away from work area.
- Comply with all applicable safety regulations.



**MOVING PARTS HAZARD**

Moving parts can pinch or amputate fingers and other body parts.

- Keep clear of moving parts.
- Do not operate equipment with protective guards or covers removed.
- Pressurized equipment can start without warning. Before checking, moving, or servicing equipment, follow the **Pressure Relief Procedure** in this manual. Disconnect power or air supply.



**BURN HAZARD**

Equipment surfaces and fluid that's heated can become very hot during operation. To avoid severe burns, do not touch hot fluid or equipment. Wait until equipment/fluid has cooled completely.

## Isocyanate Hazard

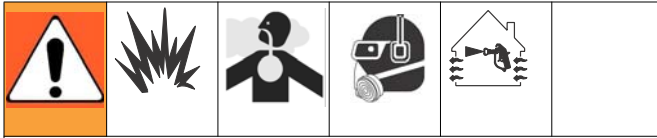

Spraying materials containing isocyanates creates potentially harmful mists, vapors, and atomized particulates.

Read material manufacturer's warnings and material MSDS to know specific hazards and precautions related to isocyanates.

Prevent inhalation of isocyanate mists, vapors, and atomized particulates by providing sufficient ventilation in the work area. If sufficient ventilation is not available, a supplied-air respirator is required for everyone in the work area.

To prevent contact with isocyanates, appropriate personal protective equipment, including chemically impermeable gloves, boots, aprons, and goggles, is also required for everyone in the work area.

## Material Self-ignition



Some materials may become self-igniting if applied too thickly. Read material manufacturer's warnings and material MSDS.

## Moisture Sensitivity of Isocyanates

Isocyanates (ISO) are catalysts used in two component foam and polyurea coatings. ISO will react with moisture (such as humidity) to form small, hard, abrasive crystals, which become suspended in the fluid. Eventually a

film will form on the surface and the ISO will begin to gel, increasing in viscosity. If used, this partially cured ISO will reduce performance and the life of all wetted parts.



The amount of film formation and rate of crystallization varies depending on the blend of ISO, the humidity, and the temperature.

To prevent exposing ISO to moisture:

- Always use a sealed container with a desiccant dryer in the vent, or a nitrogen atmosphere. **Never** store ISO in an open container.
- Keep the ISO lube pump reservoir filled with Graco Throat Seal Liquid (TSL), Part 206995. The lubricant creates a barrier between the ISO and the atmosphere.
- Use moisture-proof hoses specifically designed for ISO, such as those supplied with your system.
- Never use reclaimed solvents, which may contain moisture. Always keep solvent containers closed when not in use.
- Never use solvent on one side if it has been contaminated from the other side.
- Always park pumps when you shutdown, see page 34.
- Always lubricate threaded parts with Part 217374 ISO pump oil or grease when reassembling.

## Keep Components A and B Separate

CAUTION
To prevent cross-contamination of the equipment's wetted parts, <b>never</b> interchange component A (isocyanate) and component B (resin) parts.

## Foam Resins with 245fa Blowing Agents

New foam blowing agents will froth at temperatures above 90°F (33°C) when not under pressure, especially if agitated. To reduce frothing, minimize preheating in a circulation system.

## Changing Materials

- When changing materials, flush the equipment multiple times to ensure it is thoroughly clean.
- Always clean the fluid inlet strainers after flushing, see page 41.
- Check with your material manufacturer for chemical compatibility.
- Most materials use ISO on the A side, but some use ISO on the B side.
- Epoxies often have amines on the B (hardener) side. Polyureas often have amines on the B (resin) side.

# Typical Installation, with circulation

## Key for FIG. 1

- |   |                                |   |                                  |
|---|--------------------------------|---|----------------------------------|
| A | Reactor Proportioner           | G | Feed Pump Air Supply Lines       |
| B | Heated Hose                    | J | Fluid Supply Lines               |
| C | Fluid Temperature Sensor (FTS) | K | Feed Pumps                       |
| D | Heated Whip Hose               | L | Agitator                         |
| E | Fusion Spray Gun               | M | Desiccant Dryer                  |
| F | Gun Air Supply Hose            | P | Gun Fluid Manifold (part of gun) |
|   |                                | R | Circulation Lines                |

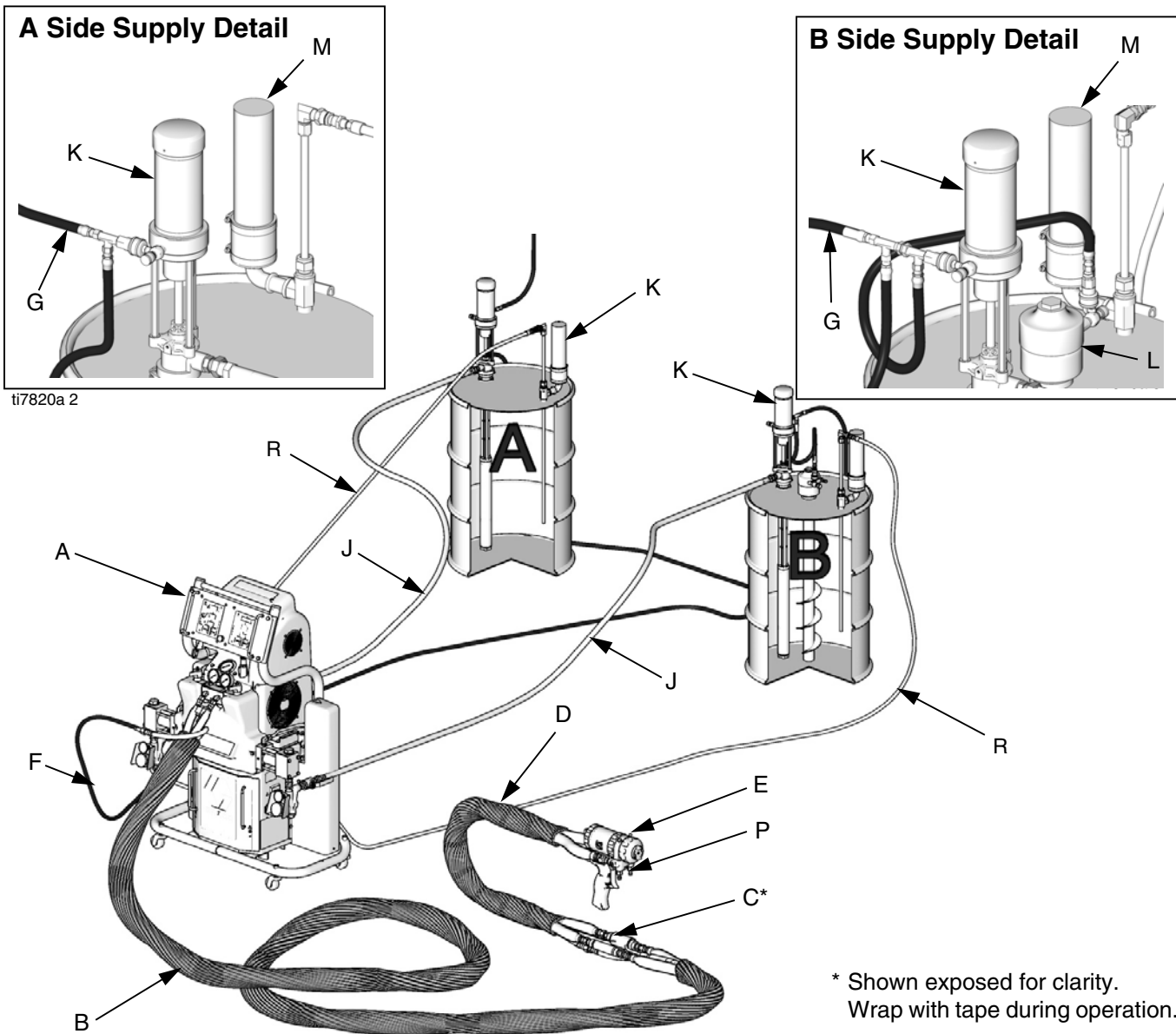
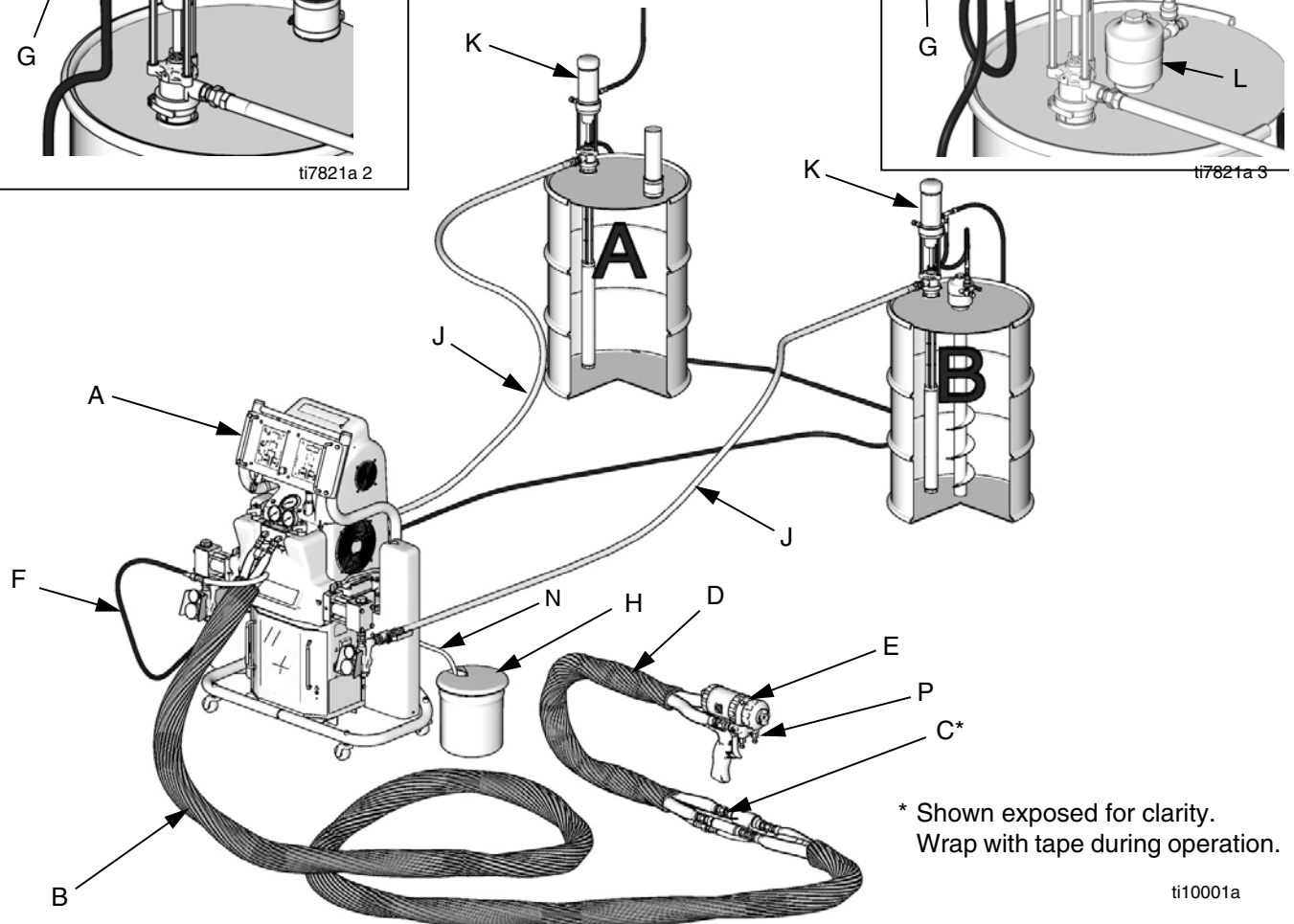
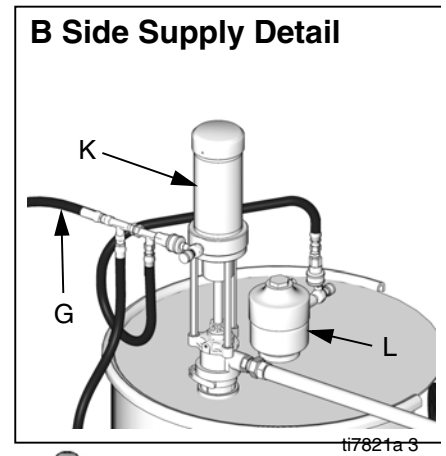
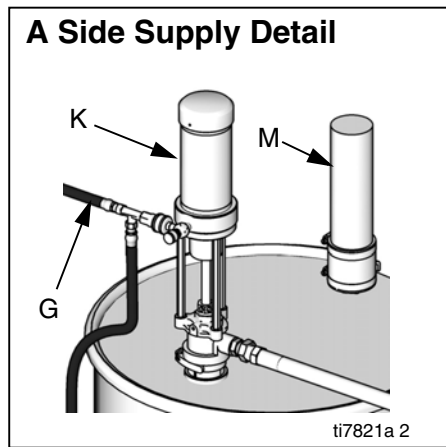

FIG. 1: Typical Installation, with circulation

# Typical Installation, without circulation

## Key for FIG. 2

- |   |                                |   |                                  |
|---|--------------------------------|---|----------------------------------|
| A | Reactor Proportioner           | H | Waste Containers                 |
| B | Heated Hose                    | J | Fluid Supply Lines               |
| C | Fluid Temperature Sensor (FTS) | K | Feed Pumps                       |
| D | Heated Whip Hose               | L | Agitator                         |
| E | Fusion Spray Gun               | M | Desiccant Dryer                  |
| F | Gun Air Supply Hose            | N | Bleed Lines                      |
| G | Feed Pump Air Supply Lines     | P | Gun Fluid Manifold (part of gun) |

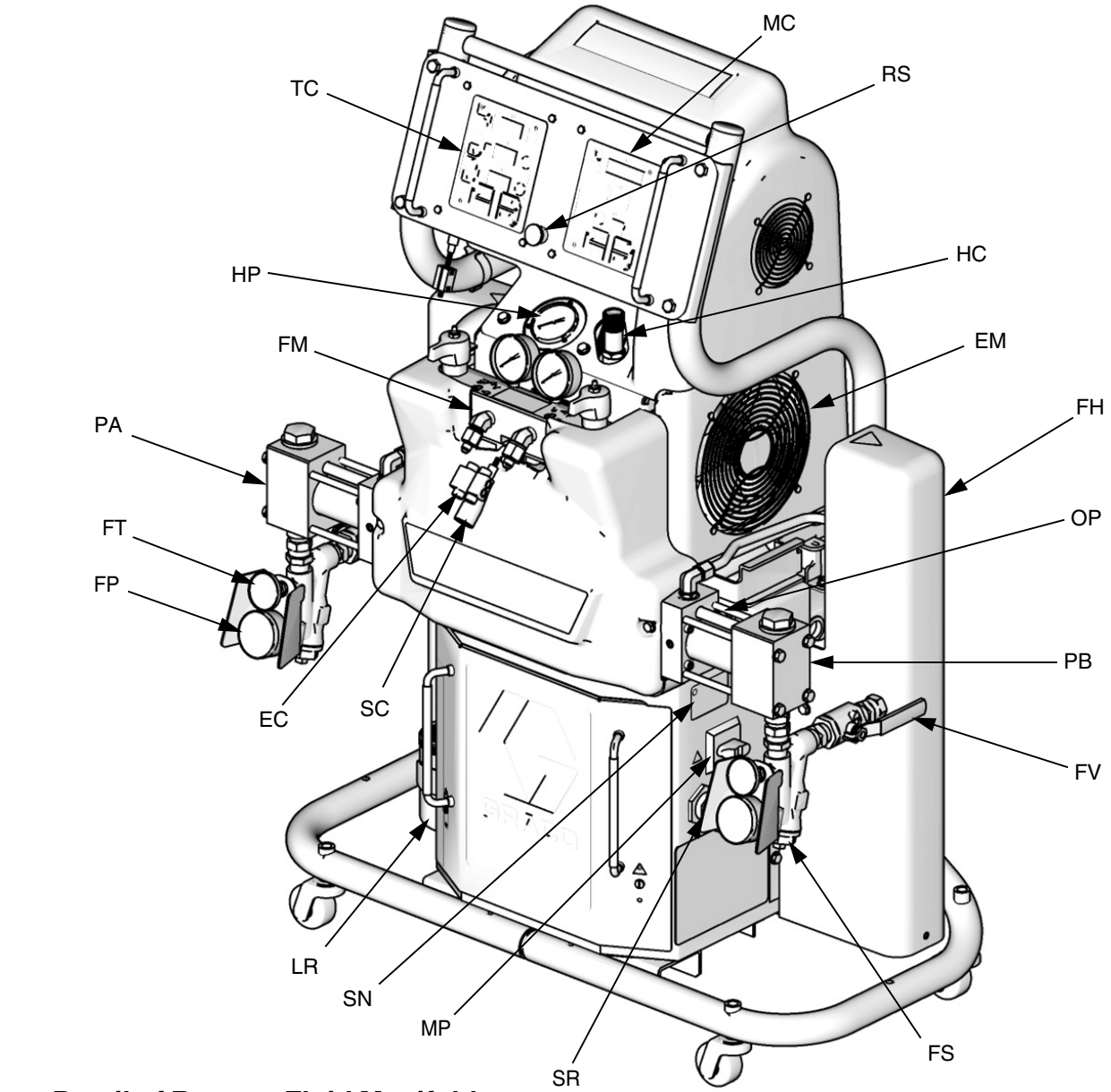

**FIG. 2: Typical Installation, without circulation**

# Component Identification

## Key for FIG. 3

BA Component A Pressure Relief Outlet  
BB Component B Pressure Relief Outlet  
EC Heated Hose Electrical Connector  
EM Electric Motor, Fan, and Belt Drive (behind shroud)  
FA Component A Fluid Manifold Inlet (on left side of manifold block)  
FB Component B Fluid Manifold Inlet  
FH Fluid Heater (behind shroud)  
FM Reactor Fluid Manifold  
FP Feed Inlet Pressure Gauge  
FS Feed Inlet Strainer  
FT Feed Inlet Temperature Gauge  
FV Fluid Inlet Valve (B side shown)  
GA Component A Outlet Pressure Gauge  
GB Component B Outlet Pressure Gauge  
HA Component A Hose Connection  
HB Component B Hose Connection  
HC Hydraulic Pressure Control  
HP Hydraulic Pressure Gauge  
LR ISO Lube Pump Reservoir  
MC Motor Control Display  
MP Main Power Switch  
OP Overpressure Rupture Disk Assembly (on rear of A and B pumps)  
PA Component A Pump  
PB Component B Pump  
RS Red Stop Button  
SA Component A PRESSURE RELIEF/SPRAY Valve  
SB Component B PRESSURE RELIEF/SPRAY Valve  
SC Fluid Temperature Sensor Cable  
SN Serial Number Plate (one inside cabinet, one on right side of cabinet)  
SR Electrical Cord Strain Relief  
TA Component A Pressure Transducer (behind gauge GA)  
TB Component B Pressure Transducer (behind gauge GB)  
TC Temperature Control Display  
TD Oil Cooler



**Detail of Reactor Fluid Manifold  
(shroud removed for clarity)**

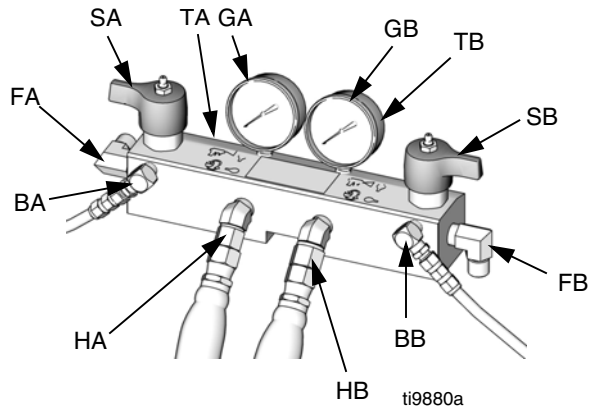

ti9880a

**Detail of Serial No.  
Plate (inside cabinet)**

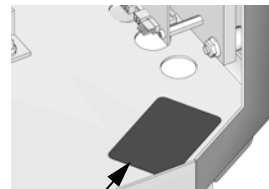

SN

Ti9830a

ti7823a

**FIG. 3: Component Identification (H40 15.3 kW Model Shown)**

# Temperature Controls and Indicators

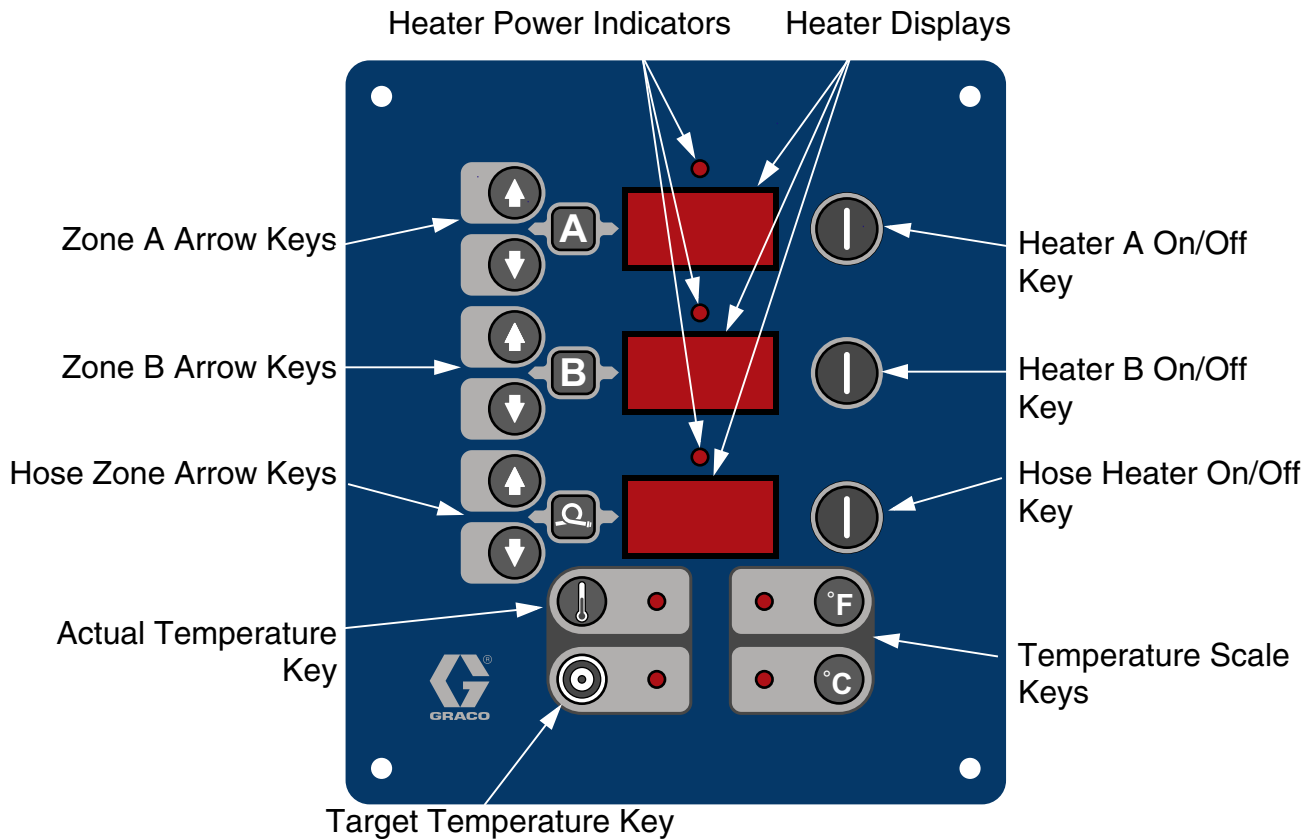

FIG. 4. Temperature Controls and Indicators

## Main Power Switch

Located on right side of unit, page 15. Turns

Reactor power ON  and OFF . Does not turn heater zones or pumps on.

## Red Stop Button

Located between temperature control panel and motor control panel, page 15. Press

 to shut off motor and heater zones only.

Use main power switch to shut off all power to unit.

## Actual Temperature Key/LED

Press  to display actual temperature.





Press and hold  to display electrical current.

## Target Temperature Key/LED

Press  to display target temperature.

Press and hold  to display heater control circuit board temperature.

## Temperature Scale Keys/LEDs

Press  or  to change temperature scale.



## Heater Zone On/Off Keys/LEDs

Press  to turn heater zones on and off. Also clears heater zone diagnostic codes, see page 38.



LEDs flash when heater zones are on. The duration of each flash shows the extent that the heater is turned on.

## Temperature Arrow Keys

Press , then press  or  to adjust temperature settings in 1 degree increments.

## Temperature Displays

Show actual temperature or target temperature of heater zones, depending on selected mode. Defaults to actual at startup. Range is 32-190°F (0-88°C) for A and B, 32-180°F (0-82°C) for hose.

\* Depending on model.

### Circuit Breakers

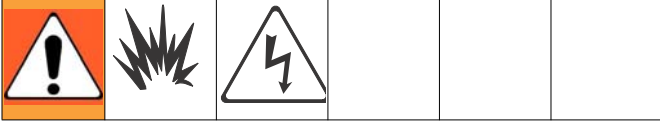

Located inside Reactor cabinet.

Ref.	Size	Component
CB1	50 A	Hose/Transformer Secondary
CB2	40 A	Transformer Primary
CB3	25, 40, or 50 A*	Heater A
CB4	25, 40, or 50 A*	Heater B
CB5	20 or 30 A*	Motor/Pumps

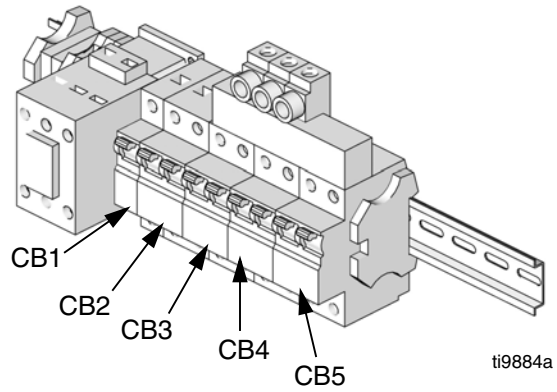

ti9884a

For wiring and cabling, see repair manual 312063.

# Motor Controls and Indicators

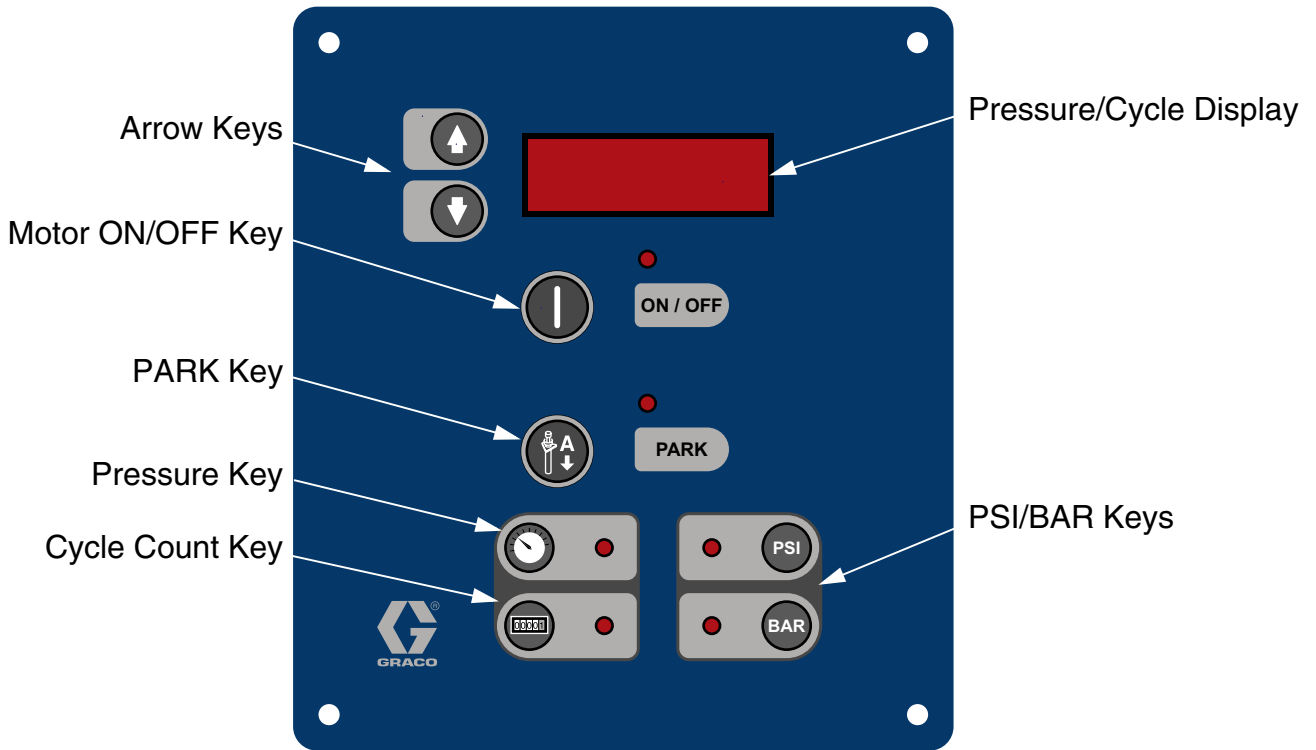



FIG. 5. Motor Controls and Indicators



## Motor ON/OFF Key/LED

Press  to turn motor ON and OFF. Also clears some motor control diagnostic codes, see page 39.

## PARK Key/LED

Press  at end of day to cycle component A pump to home position, submerging displacement rod. Trigger gun until pump stops. Once parked, motor will automatically shut off.

## PSI/BAR Keys/LEDs

Press  or  to change pressure scale.

## Pressure Key/LED

Press  to display fluid pressure.

 If pressures are imbalanced, display shows higher of two pressures.

## Cycle Count Key/LED

Press  to display cycle count.



To clear counter, press and hold  for 3 sec.

## Hydraulic Pressure Control Knob

Use to adjust hydraulic pressure available to the hydraulic drive system. Turn knob (HC) clockwise to increase pressure and counter-clockwise to decrease pressure. Use hydraulic pressure gauge (HP, page 15) to view hydraulic pressure.

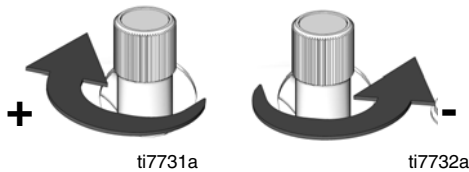

Component A and B outlet pressures will be higher than the hydraulic set pressure, depending on the model (see Pressure Ratio data; **Models**, page 3). Component A and B pressure may be viewed on the pressure gauges (GA, GB), or the higher of the two pressures may be displayed on the motor control panel (MC). See FIG. 3, page 15.

## Motor Control Arrow Keys

Use  or  to:

- Adjust pressure imbalance settings, page 30.
- Adjust standby settings, page 33.

## Spray Adjustments

Flow rate, atomization, and amount of overspray are affected by four variables.

- **Fluid pressure setting.** Too little pressure results in an uneven pattern, coarse droplet size, low flow, and poor mixing. Too much pressure results in excessive overspray, high flow rates, difficult control, and excessive wear.
- **Fluid temperature.** Similar effects to fluid pressure setting. The A and B temperatures can be offset to help balance the fluid pressure.
- **Mix chamber size.** Choice of mix chamber is based on desired flow rate and fluid viscosity.
- **Clean-off air adjustment.** Too little clean-off air results in droplets building up on the front of the nozzle, and no pattern containment to control overspray. Too much clean-off air results in air-assisted atomization and excessive overspray.

# Setup

## 1. Locate Reactor

- a. Locate Reactor on a level surface. See **Dimensions**, page 44, for clearance and mounting hole dimensions.
- b. Do not expose Reactor to rain.

<b>CAUTION</b>
Bolt Reactor to original shipping pallet before lifting.

- c. Use the casters to move Reactor to a fixed location, or bolt to shipping pallet and move with forklift.
- d. To mount on a truck bed or trailer, remove casters and bolt directly to truck or trailer bed. See page 44.

## 2. Electrical requirements

See TABLE 1.

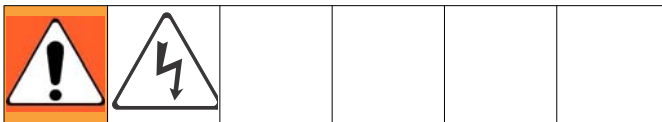

Installing this equipment requires access to parts which may cause electric shock or other serious injury if work is not performed properly. Have a qualified electrician connect power and ground to main power switch terminals, see page 22. Be sure your installation complies with all National, State and Local safety and fire codes.

**Table 1: Electrical Requirements (kW/Full Load Amps)**

Part	Model	Voltage (phase)	Full Load Peak Amps*	System Watts**
253400	H-40	230V (1)	100	23,100
253401	H-40	230V (3)	71	26,600
253402	H-40	400V (3)	41	26,600
253403	H-XP3	230V (1)	100	23,100
253404	H-XP3	230V (3)	95	31,700
253405	H-XP3	400V (3)	52	31,700
253407	H-40	230V (3)	95	31,700
253408	H-40	400V (3)	52	31,700
255400	H-25	230V (1)	69	15,960
255401	H-25	230V (3)	46	15,960
255402	H-25	400V (3)	35	15,960
255403	HXP2	230V (1)	100	23,260
255404	HXP2	230V (3)	59	23,260
255405	HXP2	400V (3)	35	23,260
255406	H-25	230V (1)	100	23,260
255407	H-25	230V (3)	59	23,260
255408	H-25	400V (3)	35	23,260
253725	H-50	230V (1)	100	23,100
253726	H-50	230V (3)	71	26,600
253727	H-50	400V (3)	41	26,600
256505	H-50	230V (3)	95	31,700
256506	H-50	400V (3)	52	31,700

\* Full load amps with all devices operating at maximum capabilities. Fuse requirements at various flow rates and mix chamber sizes may be less.

\*\* Total system watts, based on maximum hose length for each unit:

- Parts 255400 through 255408, 310 ft (94.6 m) maximum heated hose length, including whip hose.
- Parts 253400 through 253408, 410 ft (125 m) maximum heated hose length, including whip hose.

### 3. Connect electrical cord



Power cord is not supplied. See Table 2.

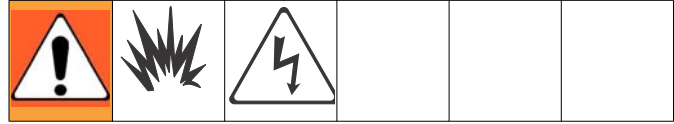

**Table 2: Power Cord Requirements**

Part	Model	Cord Specification AWG (mm <sup>2</sup> )
253400	H-40	4 (21.2), 2 wire + ground
253401	H-40	4 (21.2), 3 wire + ground
253402	H-40	8 (8.4), 4 wire + ground
253404	H-XP3	4 (21.2), 3 wire + ground
253405	H-XP3	6 (13.3), 4 wire + ground
253407	H-40	4 (21.2), 3 wire + ground
253408	H-40	6 (13.3), 4 wire + ground
255400	H-25	4 (21.2), 2 wire + ground
255401	H-25	8 (8.4), 3 wire + ground
255402	H-25	8 (8.4), 4 wire + ground
255403	H-XP2	4 (21.2), 2 wire + ground
255404	H-XP2	6 (13.3), 3 wire + ground
255405	H-XP2	8 (8.4), 4 wire + ground
255406	H-25	4 (21.2), 2 wire + ground
255407	H-25	6 (13.3), 3 wire + ground
255408	H-25	8 (8.4), 4 wire + ground
253725	H-50	4 (21.2), 2 wire + ground
253726	H-50	4 (21.2), 3 wire + ground
253727	H-50	8 (8.4), 4 wire + ground
256505	H-50	4 (21.2), 3 wire + ground
256506	H-50	6 (13.3), 4 wire + ground

- a. **230V, 1 phase:** Using 5/32 or 4 mm hex allen wrench, connect two power leads to L1 and L2. Connect green to ground (GND).

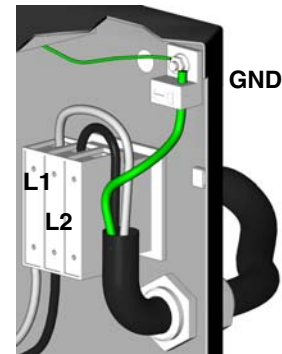

ti2515b

- b. **230V, 3 phase:** Using 5/32 or 4 mm hex allen wrench, connect three power leads to L1, L2, and L3. Connect green to ground (GND).

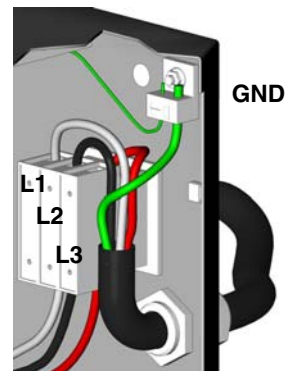

ti3248b

- c. **400V, 3 phase:** Using 5/32 or 4 mm hex allen wrench, connect three power leads to L1, L2, and L3. Connect neutral to N. Connect green to ground (GND).

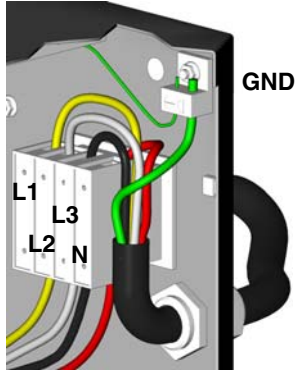

ti2725a



Some 3-phase models utilize a 3-phase motor. The motor must rotate counter-clockwise when viewed from shaft end. To reverse rotation, disconnect power and reverse power leads L1 and L2.

#### 4. Connect feed pumps

- a. Install feed pumps (K) in component A and B supply drums. See FIG. 1 and FIG. 2, pages 12 and 13.



A minimum feed pressure of 50 psi (0.35 MPa, 3.5 bar) is required at both feed inlet pressure gauges (FP). Maximum feed pressure is 250 psi (1.75 MPa, 17.5 bar). Maintain A and B feed pressures within 10% of each other.

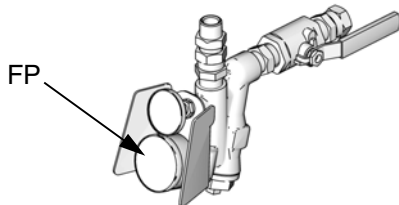

ti10006a

- b. Seal component A drum and use desiccant dryer (M) in vent.

- c. Install agitator (L) in component B drum, if necessary.
- d. Ensure A and B inlet valves (FV) are closed.

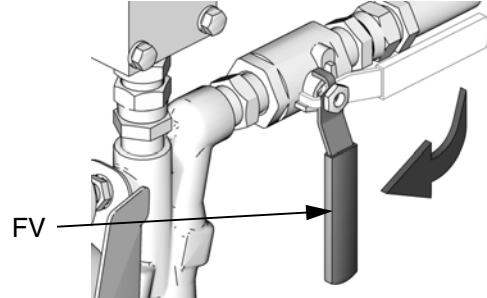

ti9883a



Supply hoses from feed pumps should be 3/4 in. (19 mm) ID.

- e. Connect and tighten component B supply hose to the 3/4 npt(f) swivel on the component B inlet valve.
- f. Connect and tighten component A supply hose to the 1/2 npt(f) swivel on the component A inlet valve.

## 5. Connect pressure relief lines



Do not install shutoffs downstream of the PRESSURE RELIEF/SPRAY valve outlets (BA, BB). The valves function as overpressure relief valves when set to SPRAY . Lines must be open so valves can automatically relieve pressure when machine is operating.

If circulating fluid back to the supply drums, use high pressure hose rated to withstand the maximum working pressure of this equipment.

- a. Recommended: Connect high pressure hose (R) to relief fittings (BA, BB) of both PRESSURE RELIEF/SPRAY valves, Route hose back to component A and B drums. See FIG. 1, page 12.

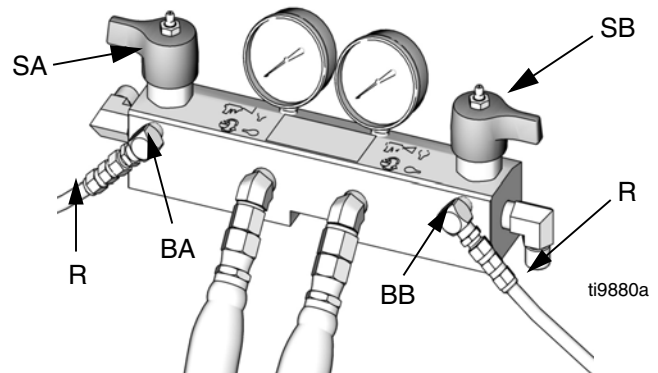

- b. **Alternately:** Secure supplied bleed tubes (N) in grounded, sealed waste containers (H). See FIG. 2, page 13.

## 6. Install Fluid Temperature Sensor (FTS)

The Fluid Temperature Sensor (FTS) is supplied. Install FTS between main hose and whip hose. See Heated Hose manual 309572 for instructions.



## 7. Connect heated hose



See Heated Hose manual 309572 for detailed instructions on connecting heated hoses.

### CAUTION

The fluid temperature sensor (C) and whip hose (D) must be used with heated hose, see page 24. Hose length, including whip hose, must be 60 ft (18.3 m) minimum.

- a. Turn main power OFF



- b. Assemble heated hose sections, FTS, and whip hose.
- c. Connect A and B hoses to A and B outlets on Reactor fluid manifold (FM). Hoses are color coded: red for component A (ISO), blue for component B (RES). Fittings are sized to prevent connection errors.

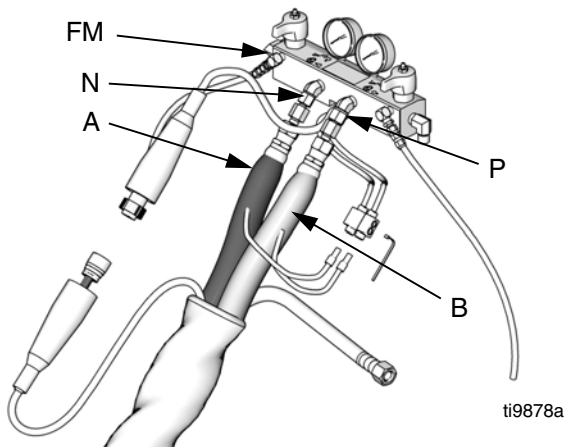

Manifold hose adapters (N, P) allow use of 1/4 in. and 3/8 in. ID fluid hoses. To use 1/2 in. (13 mm) ID fluid hoses, remove adapters from fluid manifold and install as needed to connect whip hose.

- d. Connect cables (Y). Connect electrical connectors (V). Be sure cables have slack when hose bends. Wrap cable and electrical connections with electrical tape.

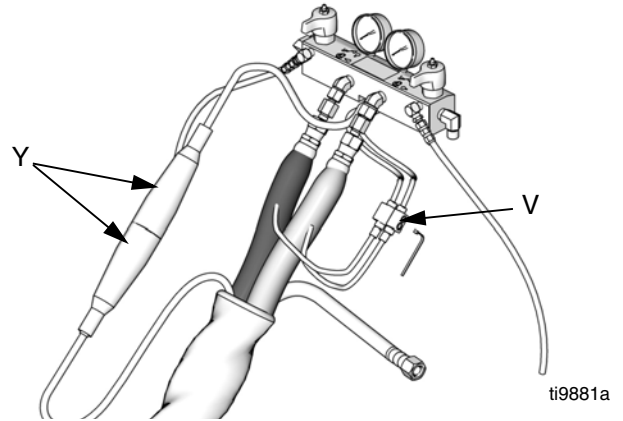

## 8. Close gun fluid manifold valves A and B

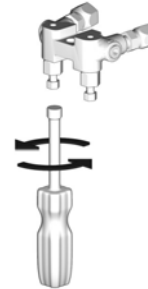

## 9. Connect whip hose to gun fluid manifold

Do not connect manifold to gun.

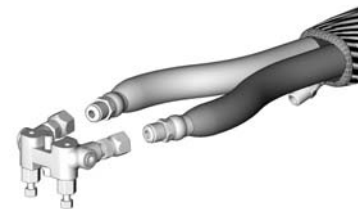

## 10. Pressure check hose

See hose manual. Pressure check for leaks. If no leaks, wrap hose and electrical connections to protect from damage.

## 11. Ground system

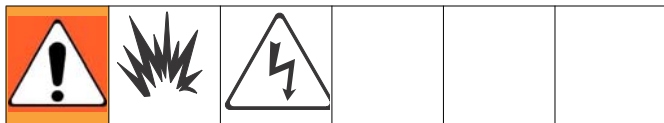

- Reactor*: is grounded through power cord. See page 22.
- Spray gun*: connect whip hose ground wire to FTS, page 24. Do not disconnect wire or spray without whip hose.
- Fluid supply containers*: follow your local code.
- Object being sprayed*: follow your local code.
- Solvent pails used when flushing*: follow your local code. Use only metal pails, which are conductive, placed on a grounded surface. Do not place pail on a nonconductive surface, such as paper or cardboard, which interrupts grounding continuity
- To maintain grounding continuity when flushing or relieving pressure*, hold a metal part of spray gun firmly to the side of a grounded *metal* pail, then trigger gun.

## 12. Check hydraulic fluid level

Hydraulic reservoir is filled at the factory. Check fluid level before operating the first time, and weekly thereafter. See **Maintenance**, page 40.

## 13. Lubrication system setup

**Component A (ISO) Pump**: Fill ISO lube reservoir (LR) with Graco Throat Seal Liquid (TSL), Part 206995 (supplied).

- Lift the lubricant reservoir (LR) out of the bracket (RB) and remove the container from the cap.

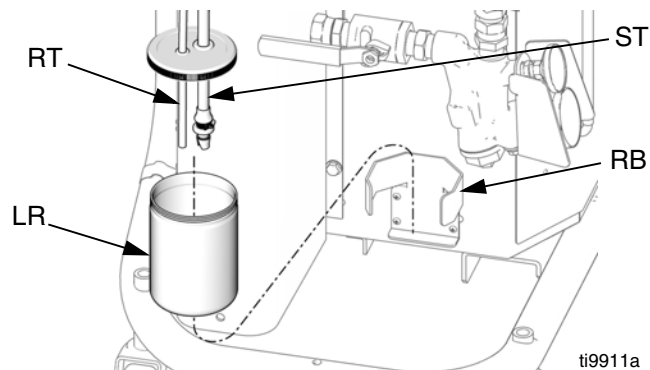

- Fill with fresh lubricant. Thread the reservoir onto the cap assembly and place it in the bracket (RB).
- Push the larger diameter supply tube (ST) approximately 1/3 of the way into the reservoir.
- Push the smaller diameter return tube (RT) into the reservoir until it reaches the bottom.



**Important:** The return tube (RT) must reach the bottom of the reservoir, to ensure that isocyanate crystals will settle to the bottom and not be siphoned into the supply tube (ST) and returned to the pump.

- The lubrication system is ready for operation. No priming is required.

# Startup

Do not operate Reactor without all covers and shrouds in place.					

## 1. Load fluid with feed pumps



The Reactor is tested with oil at the factory. Flush out the oil with a compatible solvent before spraying. See page 43.

- Check that all **Setup** steps are complete.
- Check that inlet screens are clean before daily startup, page 41.
- Check level and condition of ISO lube daily, page 40.
- Turn on component B agitator, if used.
- Turn both PRESSURE RELIEF/SPRAY

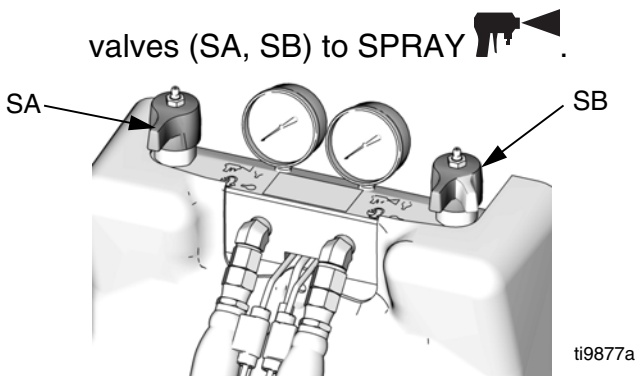

- Start feed pumps.

- Open fluid inlet valves (FV). Check for leaks.

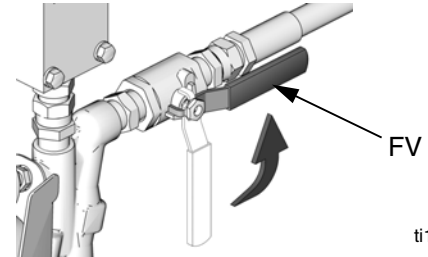

Do not mix components A and B during startup. Always provide two grounded waste containers to keep component A and component B fluids separate.					

- Use feed pumps to load system. Hold gun fluid manifold over two grounded waste containers. Open fluid valves A and B until clean, air-free fluid comes from valves. Close valves.

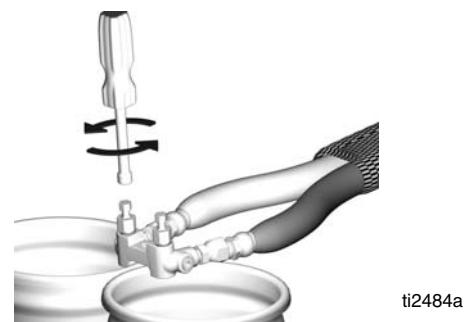

## 2. Set temperatures

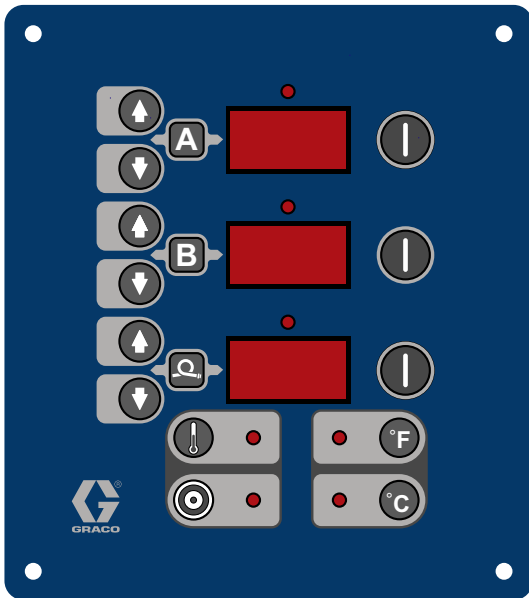

**Temperature Controls and Indicators**, see page 16

- d. To set **A** heat zone target temperature, press or until display shows desired temperature. Repeat for **B** and **P** zones.

For **P** zone only, if FTS is disconnected at startup, display will show hose current (0A). See step j, page 29.

- e. Press to display actual temperatures.

<p>This equipment is used with heated fluid, which can cause equipment surfaces to become very hot. To avoid severe burns:</p> <ul style="list-style-type: none"> <li>• Do not touch hot fluid or equipment.</li> <li>• Allow equipment to cool completely before touching it.</li> <li>• Wear gloves if fluid temperature exceeds 110°F (43°C).</li> </ul>					

- a. Turn main power ON .

- b. Press or to change temperature scale.

- c. Press .

<p>Do not turn on hose heat without fluid in hoses.</p>					

- f. Turn on **P** heat zone by pressing . Preheat hose (15-60 min). Indicator will flash very slowly when fluid reaches target temperature. Display shows actual fluid temperature in hose near FTS.

<p>Thermal expansion can cause overpressurization, resulting in equipment rupture and serious injury, including fluid injection. Do not pressurize system when preheating hose.</p>					

g. Turn on **A** and **B** heat zones by pressing **I** for each zone.

h. Hold **⊏** to view electrical currents for each zone.

i. Hold **⊕** to view heater control circuit board temperature.

j. **Manual current control mode only:**

<p>When in manual current control mode, monitor hose temperature with thermometer. Install per instructions below. Thermometer reading must not exceed 160°F (71°C). Never leave machine unattended when in manual current control mode.</p>					

If FTS is disconnected or display shows diagnostic code E04, turn main power

switch OFF then ON to clear diagnostic code and enter manual current control mode. **⊏** display will show current to hose. Current is not limited by target temperature.

To prevent overheating, install hose thermometer close to gun end, within operator view. Insert thermometer through foam cover of A component hose so stem is next to inner tube. Thermometer reading will be about 20°F less than actual fluid temperature.

If thermometer reading exceeds 160°F (71°C), reduce current with **⊏** key.

### 3. Set pressure

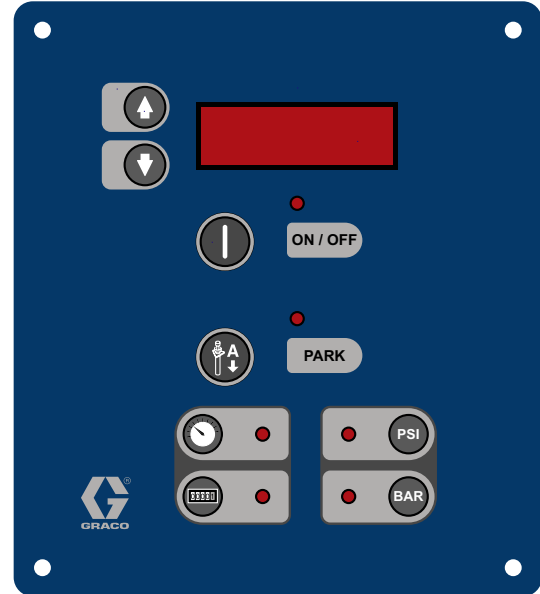

**Motor Controls and Indicators**, see page 19

a. Press **⌚** to display the pressure reading.

b. Press motor **⊏**. Motor and pumps start. Display shows system pressure.

Motor must rotate counterclockwise when viewed from shaft end. See **Connect electrical cord**, page 22.

- c. Adjust hydraulic pressure control until display shows desired fluid pressure.

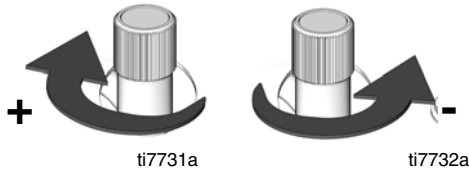

If display pressure is greater than desired pressure, reduce the hydraulic pressure and trigger gun to reduce pressure.

Check the pressure of each proportioning pump using the component A and B gauges. The pressures should be approximately equal and must remain fixed.

- d. To display cycle count, press .

To clear counter, press and hold  for 3 sec.

- e. Press  or  to change pressure scale.

#### 4. Change pressure imbalance setting (optional)



The pressure imbalance function (status code 24, page 39) detects conditions that can cause off-ratio spray, such as loss of feed pressure/supply, pump seal failure, clogged fluid inlet filter, or a fluid leak.



Code 24 (pressure imbalance) is set to an alarm as the default. To change to a warning, see Reactor Repair-Parts manual 312063.

The pressure imbalance default is factory-set at 500 psi (3.5 MPa, 35 bar). For tighter ratio error detection, select a lower value. For looser detection or to avoid nuisance alarms, select a higher value.

- a. Turn main power switch OFF .

- b. Press and hold  or , then turn main power switch ON . Display will read dP500 for psi or dP\_35 for bar.



- c. Press  or  to select desired pressure differential (100-999 in increments of 100 psi, or 7-70 in increments of 7 bar). See TABLE 3.

Table 3: Available Pressure Imbalance Settings

PSI	BAR	PSI	BAR
100	7	600	42
200	14	700	49
300	21	800	56
400	28	900	63
*500	*35	999	69

\* Factory default setting.

- d. Turn main power switch OFF  to save changes.

# Spraying



1. Engage gun piston safety lock.



ti2409a

2. Close gun fluid manifold valves A and B.

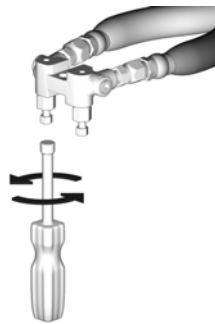

ti2728a

3. Attach gun fluid manifold. Connect gun air line. Open air line valve.

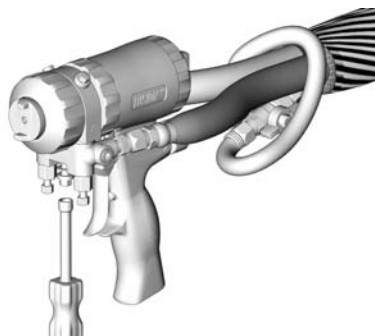

ti2543a

4. Set PRESSURE RELIEF/SPRAY valves (SA, SB) to SPRAY .

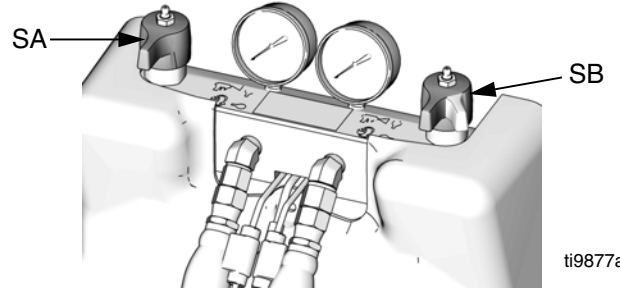

ti9877a

5. Check that heat zones are on and temperatures are on target, page 28.

6. Press motor  to start motor and pumps.

7. Check fluid pressure display and adjust as necessary.

8. Check fluid pressure gauges (GA, GB) to ensure proper pressure balance. If imbalanced, reduce pressure of higher component by **slightly** turning PRESSURE RELIEF/SPRAY valve for that component toward PRESSURE RELIEF/CIRCULA-

 TION, until gauges show balanced pressures.

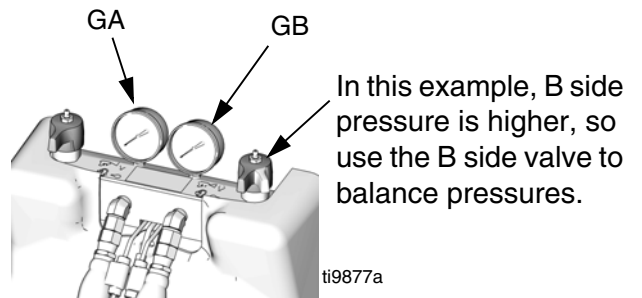

ti9877a

9. Open gun fluid manifold valves A and B.

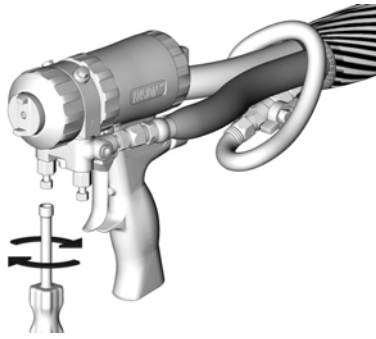

ti2414a



On impingement guns, **never** open fluid manifold valves or trigger gun if pressures are imbalanced.

10. Disengage gun piston safety lock.



ti2410a

11. Test spray onto cardboard. Adjust pressure and temperature to get desired results.

12. Equipment is ready to spray.



If you stop spraying for a period of time, the unit will enter standby (if enabled). See page 33.



# Standby

If you stop spraying for a period of time, the unit will enter standby by shutting down the electric motor and hydraulic pump, to reduce equipment wear and minimize heat buildup. The ON/OFF LED and the pressure/cycle display on the motor control panel will flash when in standby.



The **A**, **B**, and **Q** heat zones will not be shut off in standby.







To restart, spray off target for 2 sec. The system will sense the pressure drop and the motor will ramp up to full speed in a few seconds.





This feature is disabled from the factory.

To activate or disable standby, adjust DIP switch #3 on the motor control board. See Reactor Repair-Parts manual 312063.

The idle time before entering standby is user-settable as follows:

1. Turn main power switch OFF .
2. Press and hold , then turn main power switch ON .
3. Press  or  to select desired timer setting (5-20, in 5 minute increments). This sets the length of inactive time before the unit will enter standby.
4. Turn main power switch OFF  to save changes.

# Shutdown

1. Shut off **A** , **B** , and **Q** heat zones.
2. Park pumps.
  - a. Press .
  - b. Trigger gun until pump A stops in the retracted position and the pressure of both pumps bleeds down.
3. Turn main power OFF .

4. Close both fluid supply valves (FV).

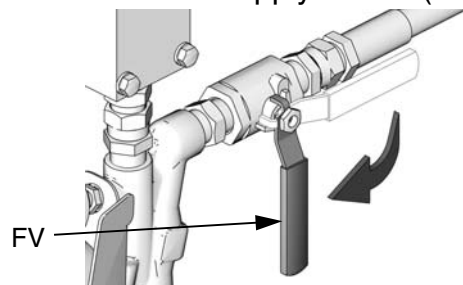

ti9883a

5. Relieve pressure, page 35.
6. Shut down feed pumps as required.

# Pressure Relief Procedure

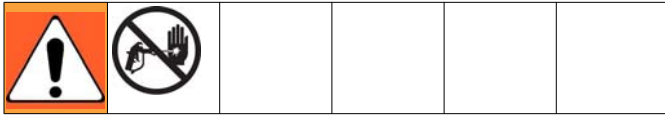

1. Relieve pressure in gun and perform gun shutdown procedure. See gun manual.
2. Close gun fluid manifold valves A and B.

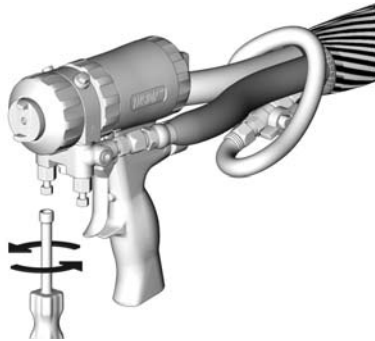

ti2421a

3. Shut off feed pumps and agitator, if used.

4. Turn PRESSURE RELIEF/SPRAY valves (SA, SB) to PRESSURE RELIEF/CIRCULATION . Route fluid to waste containers or supply tanks. Ensure gauges drop to 0.

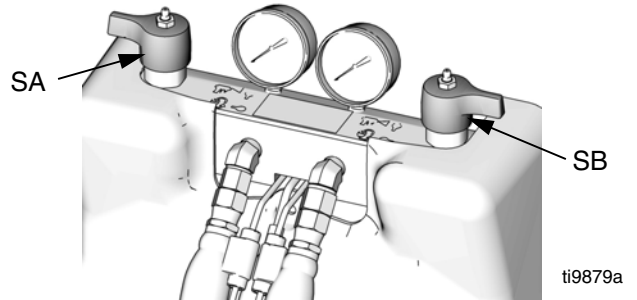

ti9879a

5. Engage gun piston safety lock.



ti2409a

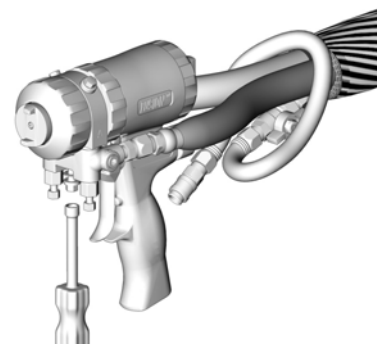

6. Disconnect gun air line and remove gun fluid manifold.



ti2554a



# Fluid Circulation

## Circulation Through Reactor

					
Do not circulate fluid containing a blowing agent without consulting with your material supplier regarding fluid temperature limits.					

To circulate through gun manifold and preheat hose, see page 37.

### 1. Load fluid with feed pumps, page 27.



					
Do not install shutoffs downstream of the PRESSURE RELIEF/SPRAY valve outlets (BA, BB). The valves function as overpressure relief valves when set to SPRAY  . Lines must be open so valves can automatically relieve pressure when machine is operating.					

2. See **Typical Installation, with circulation**, page 12. Route circulation lines back to respective component A or B supply drum. Use hoses rated at the maximum working pressure of this equipment. See **Technical Data**, page 45.

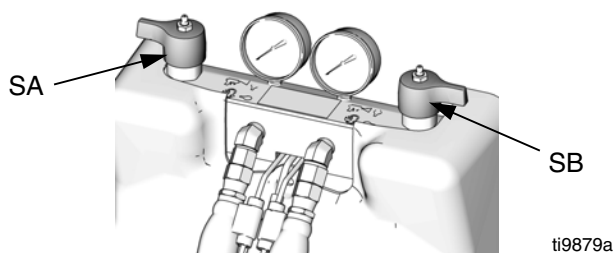
3. Set PRESSURE RELIEF/SPRAY valves (SA, SB) to PRESSURE RELIEF/CIRCULATION .





4. Turn main power ON .

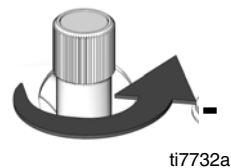

5. Set temperature targets, see page 28. Turn on **A** and **B** heat zones by pressing  and . **Do not** turn on  heat zone unless hoses are already loaded with fluid.

6. Press  to display actual temperatures.

7. Before starting motor, reduce hydraulic pressure to the minimum required to circulate fluid until **A** and **B** temperatures reach targets.





8. Press motor  to start motor and pumps. Circulate fluid at lowest possible pressure until temperatures reach targets.

9. Turn on  heat zone by pressing .

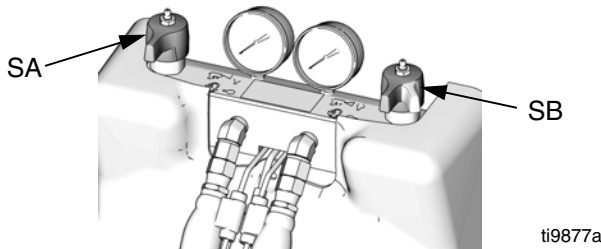
10. Set PRESSURE RELIEF/SPRAY valves (SA, SB) to SPRAY .



## Circulation Through Gun Manifold

					
Do not circulate fluid containing a blowing agent without consulting with your material supplier regarding fluid temperature limits.					

Circulating fluid through the gun manifold allows rapid preheating of hose.

1. Install gun fluid manifold (P) on Part 246362 accessory circulation kit (CK). Connect high pressure circulation lines (R) to circulation manifold.

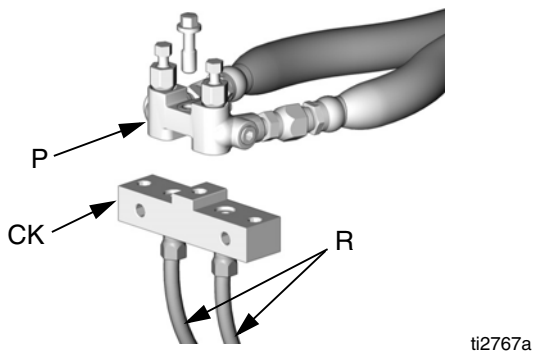





2. Route circulation lines back to respective component A or B supply drum. Use hoses



rated at the maximum working pressure of this equipment. See **Typical Installation, without circulation**, page 13.

3. Follow **Load fluid with feed pumps**, page 27.

4. Turn main power ON .

5. Set temperature targets, see page 28. Turn on , , and  heat zones by pressing .

6. Press  to display actual temperatures.

7. Before starting motor, reduce hydraulic pressure to the minimum required to circulate fluid until  and  temperatures reach targets.

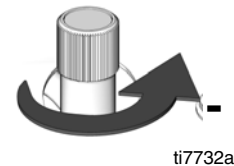

8. Press motor  to start motor and pumps. Circulate fluid at lowest possible pressure until temperatures reach targets.

# Diagnostic Codes

## Temperature Control Diagnostic Codes

Temperature control diagnostic codes appear on temperature display.

These alarms turn off heat. E99 clears automatically when communication is regained. Codes E03 through E06 can be cleared by

pressing . For other codes, turn main

power OFF  then ON  to clear.

See repair manual for corrective action.

Code	Code Name	Alarm Zone
01	High fluid temperature	Individual
02	High current	Individual
03	No current	Individual
04	FTS not connected	Individual
05	Board overtemperature	Individual
06	Loss of zone communication	Individual
30	Momentary loss of communication	All
99	Loss of display communication	All



For hose zone only, if FTS is disconnected at startup, display will show hose current 0A.

## Motor Control Diagnostic Codes

Motor control diagnostic codes E21 through E27 appear on pressure display.

There are two types of motor control codes: alarms and warnings. Alarms take priority over warnings.

See repair manual for corrective action.

### Alarms

Alarms turn off Reactor. Turn main power OFF



Alarms can also be cleared, except for code 23, by pressing .



Code 24 (pressure imbalance) is set to an alarm default of 500 psi (3.5 MPa, 35 bar). To change to a warning, see Reactor Repair-Parts manual 312063. To change the default pressure imbalance setting, see page 30.

### Warnings

Reactor will continue to run. Press  to clear. A warning will not recur for a predetermined amount of time (varies for different warnings), or until main power is turned OFF

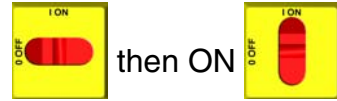

Code No.	Code Name	Alarm or Warning
21	No transducer (component A)	Alarm
22	No transducer (component B)	Alarm
23	High pressure	Alarm
24	Pressure imbalance	Selectable; see repair manual
27	High motor temperature	Alarm
30	Momentary loss of communication	Alarm
31	Pumpline switch failure/high cycle rate	Alarm
99	Loss of communication	Alarm

# Maintenance

- Inspect hydraulic and fluid lines for leaks daily.
- Clean up all hydraulic leaks; identify and repair cause of leak.
- Inspect fluid inlet strainer screens daily, see below.
- Grease circulation valves weekly with Fusion grease (117773).

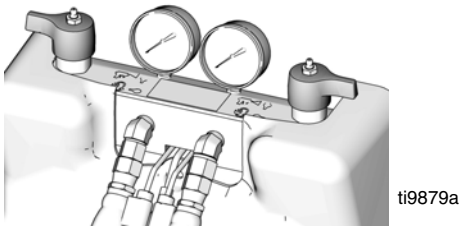

- Inspect ISO lubricant level and condition daily, see page 42. Refill or replace as needed.
- Check hydraulic fluid level weekly. Check hydraulic fluid level on dipstick (DS). Fluid level must be between indent marks (IM) on dipstick. Refill as required with approved hydraulic fluid; see **Technical Data** on page 45 and the **Approved Anti-Wear (AW) Hydraulic Oils** table in the Reactor Repair-Parts manual 312063. If fluid is dark in color, change fluid and filter.

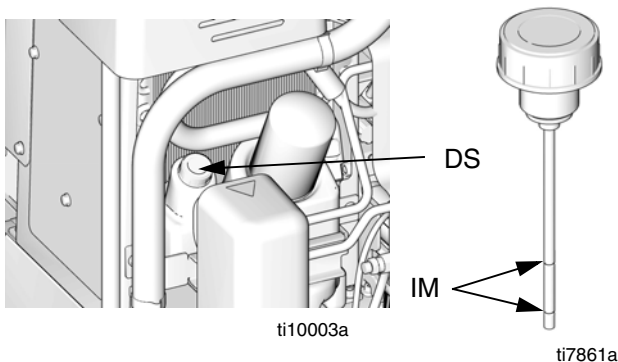

- Change break-in oil in a new unit after first 250 hours of operation or within 3 months, whichever comes first. See Table 4 for recommended frequency of oil changes

**Table 4: Frequency of Oil Changes**

Ambient Temperature	Recommended Frequency
0 to 90°F (-17 to 32°C)	1000 hours or 12 months, whichever comes first
90°F and above (32°C and above)	500 hours or 6 months, whichever comes first

- Keep component A from exposure to moisture in atmosphere, to prevent crystallization.
- Clean gun mix chamber ports regularly. See gun manual.
- Clean gun check valve screens regularly. See gun manual.
- Use compressed air to prevent dust buildup on control boards, fan, motor (under shield), and hydraulic oil coolers.
- Keep vent holes on bottom of electrical cabinet open.



## Fluid Inlet Strainer Screen



The inlet strainers filter out particles that can plug the pump inlet check valves. Inspect the screens daily as part of the startup routine, and clean as required.

Use clean chemicals and follow proper storage, transfer, and operating procedures, to minimize contamination of the A-side screen.



Clean the A-side screen only during daily startup. This minimizes moisture contamination by immediately flushing out any isocyanate residue at the start of dispensing operations.

1. Close the fluid inlet valve at the pump inlet and shut off the appropriate feed pump. This prevents material from being pumped while cleaning the screen.
2. Place a container under the strainer manifold (59d) to catch fluid. Remove the strainer plug (59j).
3. Remove the screen (59g) from the strainer manifold. Thoroughly flush the screen with compatible solvent and shake it dry. Inspect the screen. If more than 25% of the mesh is blocked, replace the screen. Inspect the gasket (59h) and replace as required.
4. Ensure the pipe plug (59k) is screwed into the strainer plug (59j). Install the strainer plug with the screen (59g) and gasket (59h) in place and tighten. Do not overtighten. Let the gasket make the seal.

5. Open the fluid inlet valve, ensure that there are no leaks, and wipe the equipment clean. Proceed with operation.

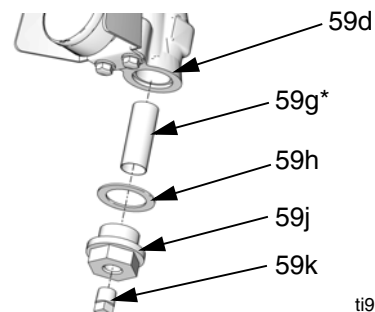

ti9886a

**FIG. 6. Fluid Inlet Strainer**

*\* See Reactor Repair-Parts manual 312063 for fluid filter screen replacements.*

## Pump Lubrication System



Check the condition of the ISO pump lubricant daily. Change the lubricant if it becomes a gel, its color darkens, or it becomes diluted with isocyanate.

Gel formation is due to moisture absorption by the pump lubricant. The interval between changes depends on the environment in which the equipment is operating. The pump lubrication system minimizes exposure to moisture, but some contamination is still possible.

Lubricant discoloration is due to continual seepage of small amounts of isocyanate past the pump packings during operation. If the packings are operating properly, lubricant replacement due to discoloration should not be necessary more often than every 3 or 4 weeks.

To change pump lubricant:

1. Relieve pressure, page 35.
2. Lift the lubricant reservoir (LR) out of the bracket (RB) and remove the container from the cap. Holding the cap over a suitable container, remove the check valve and allow the lubricant to drain. Reattach the check valve to the inlet hose. See FIG. 7.
3. Drain the reservoir and flush it with clean lubricant.
4. When the reservoir is flushed clean, fill with fresh lubricant.
5. Thread the reservoir onto the cap assembly and place it in the bracket.

6. Push the larger diameter supply tube (ST) approximately 1/3 of the way into the reservoir.

7. Push the smaller diameter return tube (RT) into the reservoir until it reaches the bottom.



**Important:** The return tube (RT) must reach the bottom of the reservoir, to ensure that isocyanate crystals will settle to the bottom and not be siphoned into the supply tube (ST) and returned to the pump.

8. The lubrication system is ready for operation. No priming is required.

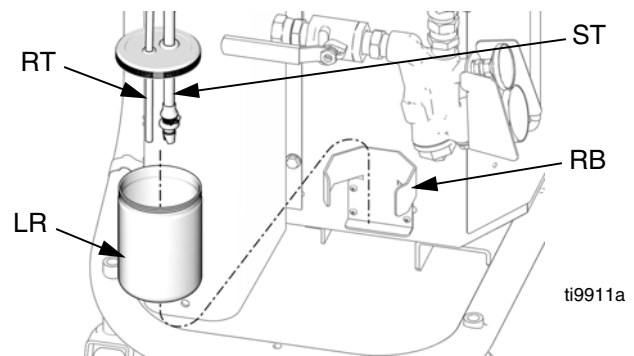

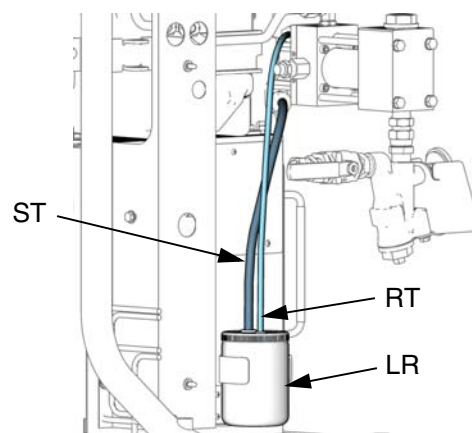

ti9911a



ti9887a

**FIG. 7. Pump Lubrication System**

# Flushing

					
Flush equipment only in a well-ventilated area. Do not spray flammable fluids. Do not turn on heaters while flushing with flammable solvents.					

- Flush out old fluid with new fluid, or flush out old fluid with a compatible solvent before introducing new fluid.
- Use the lowest possible pressure when flushing.
- All fluid components are compatible with common solvents. Use only moisture-free solvents.

- To flush feed hoses, pumps, and heaters separately from heated hoses, set PRESSURE RELIEF/SPRAY valves (SA, SB) to

PRESSURE RELIEF/CIRCULATION . Flush through bleed lines (N).

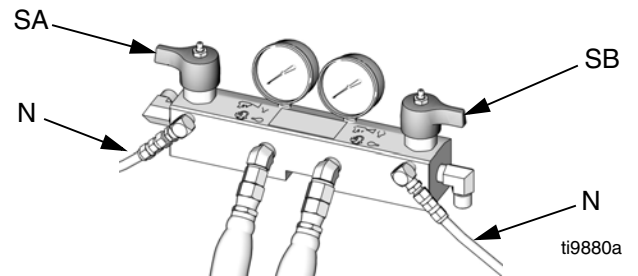

- To flush entire system, circulate through gun fluid manifold (with manifold removed from gun).
- To prevent moisture from reacting with isocyanate, always leave the system dry or filled with a moisture-free plasticizer or oil. Do not use water. See page 10.

# Dimensions

Dimension	in. (mm)	Dimension	in. (mm)
A (height)	55.0 (1397)	F (side mounting holes)	16.25 (413)
B (width)	39.6 (1006)	G (mounting post inner diameter)	0.44 (11)
C (depth)	18.5 (470)	H (front mounting post height)	2.0 (51)
D (front mounting holes)	29.34 (745)	J (rear mounting post height)	3.6 (92)
E (rear mounting holes)	33.6 (853)		

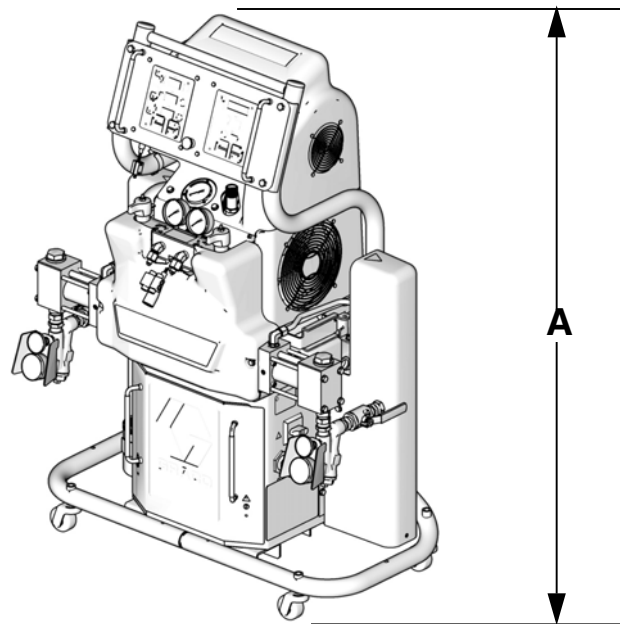

T19830a

## Top View

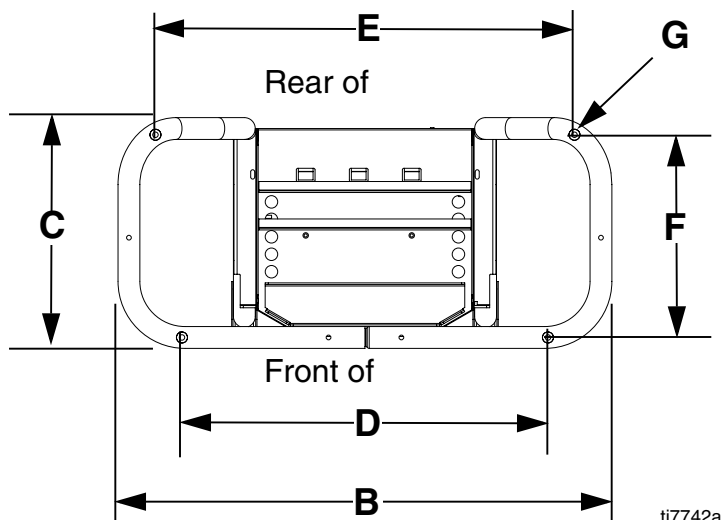

ti7742a

## Side View

Detail of mounting post height, to correctly size mounting bolts

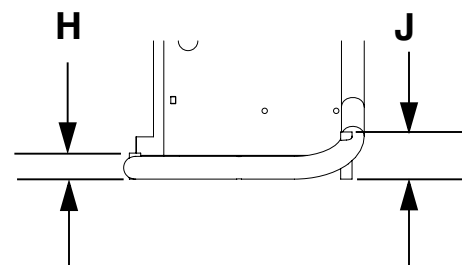

ti7743a

# Technical Data

Category	Data
Maximum Fluid Working Pressure	Models H-25 and H-40: 2000 psi (13.8 MPa, 138 bar) Model H-50 1 phase: 1700 psi (11.7 MPa, 11.7 bar) Model H-50 3 phase: 2000 psi (13.8 MPa, 138 bar) Models H-XP2 and H-XP3: 3500 psi (24.1 MPa, 241 bar)
Fluid:Oil Pressure Ratio	Models H-25 and H-40: 1.91:1 Model H-50: 1.64:1 Models H-XP2 and H-XP3: 2.79:1
Fluid Inlets	Component A (ISO): 1/2 npt(f), 250 psi (1.75 MPa, 17.5 bar) maximum Component B (RES): 3/4 npt(f), 250 psi (1.75 MPa, 17.5 bar) maximum
Fluid Outlets	Component A (ISO): #8 (1/2 in.) JIC (3/4-16 unf), with #5 (5/16 in.) JIC adapter Component B (RES): #10 (5/8 in.) JIC (7/8-14 unf), with #6 (3/8 in.) JIC adapter
Fluid Circulation Ports	1/4 npsm(m), with plastic tubing, 250 psi (1.75 MPa, 17.5 bar) maximum
Maximum Fluid Temperature	190°F (88°C)
Maximum Output (10 weight oil at ambient temperature)	Model H-25: 22 lb/min (10 kg/min) (60 Hz) Model H-XP2: 1.5 gpm (5.7 liter/min) (60 Hz) Model H-50: 52 lb/min (24 kg/min) (60 Hz) Model H-40: 45 lb/min (20 kg/min) (60 Hz) Model H-XP3: 2.8 gpm (10.6 liter/min) (60 Hz)
Output per Cycle (A and B)	Models H-25 and H-40: 0.063 gal. (0.23 liter) Model H-50: 0.073 gal. (0.28 liter) Models H-XP2 and H-XP3: 0.042 gal. (0.16 liter)
Line Voltage Requirement	230V 1 phase and 230V 3 phase units: 195-264 Vac, 50/60 Hz 400V 3 phase units: 338-457 Vac, 50/60 Hz
Amperage Requirement	See <b>Models</b> , page 3.
Heater Power (A and B heaters total, no hose)	See <b>Models</b> , page 3.
Hydraulic reservoir capacity	3.5 gal. (13.6 liters)
Recommended hydraulic fluid	Citgo A/W Hydraulic Oil, ISO Grade 46
Sound power, per ISO 9614-2	90.2 dB(A)
Sound pressure, 1 m from equipment	82.6 dB(A)
Weight	Units with 8.0 kW Heaters: 535 lb (243 kg) Units with 12.0 kW Heaters: 597 lb (271 kg) Units with 15.3 kW Heaters (H-25/H-XP2 models):562 lb (255 kg) Units with 15.3 kW Heaters (H-40/H-XP3/H-50 models): 597 lb (271 kg) Units with 20.4 kW Heaters: 597 lb (271 kg)
Wetted Parts	Aluminum, stainless steel, zinc-plated carbon steel, brass, carbide, chrome, fluoroelastomer, PTFE, ultra-high molecular weight polyethylene, chemically resistant o-rings

All other brand names or marks are used for identification purposes and are trademarks of their respective owners.

# Performance Charts

### Foam Performance Chart

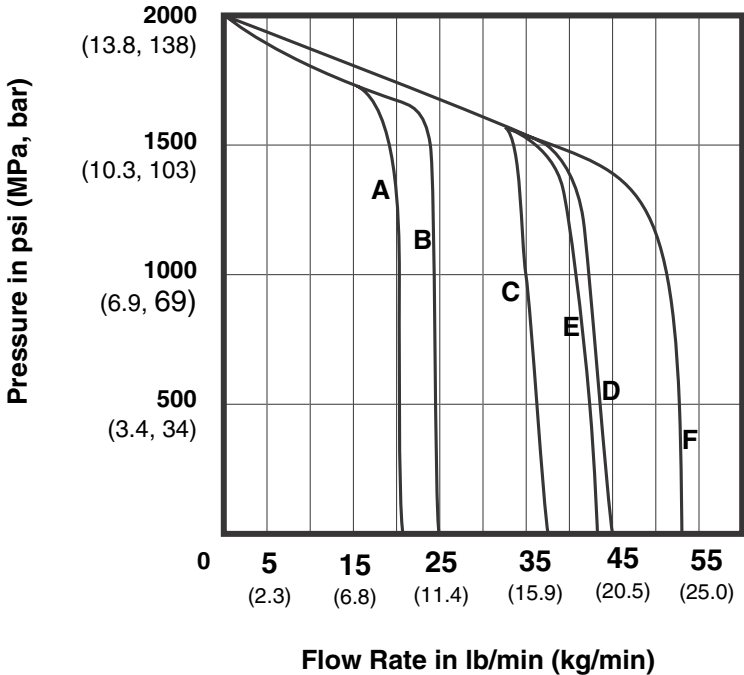

- KEY**  
 A = H-25 at 50 Hz  
 B = H-25 at 60 Hz  
 C = H-40 at 50 Hz  
 D = H-40 at 60 Hz  
 E = H-50 at 50 Hz  
 \*F = H-50 at 60 Hz

\* Pressure flow curve for model 253725 (H-50 230V 1 phase) not shown.  
 Maximum pressure limited to 1700 psi (11.7 MPa, 11.7 bar)

### Coatings Performance Chart

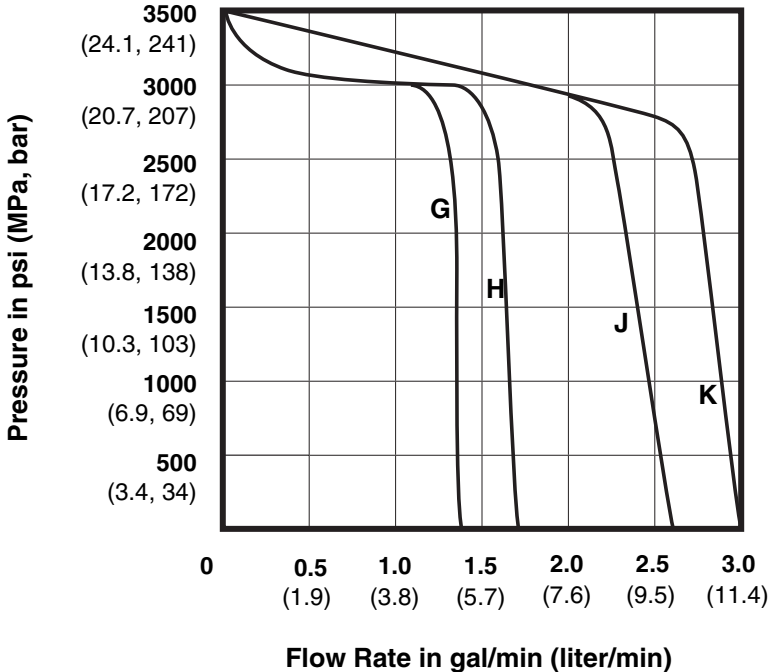

- KEY**  
 G = H-XP2 at 50 Hz  
 H = H-XP2 at 60 Hz  
 J = H-XP3 at 50 Hz  
 K = H-XP3 at 60 Hz

### Heater Performance Chart

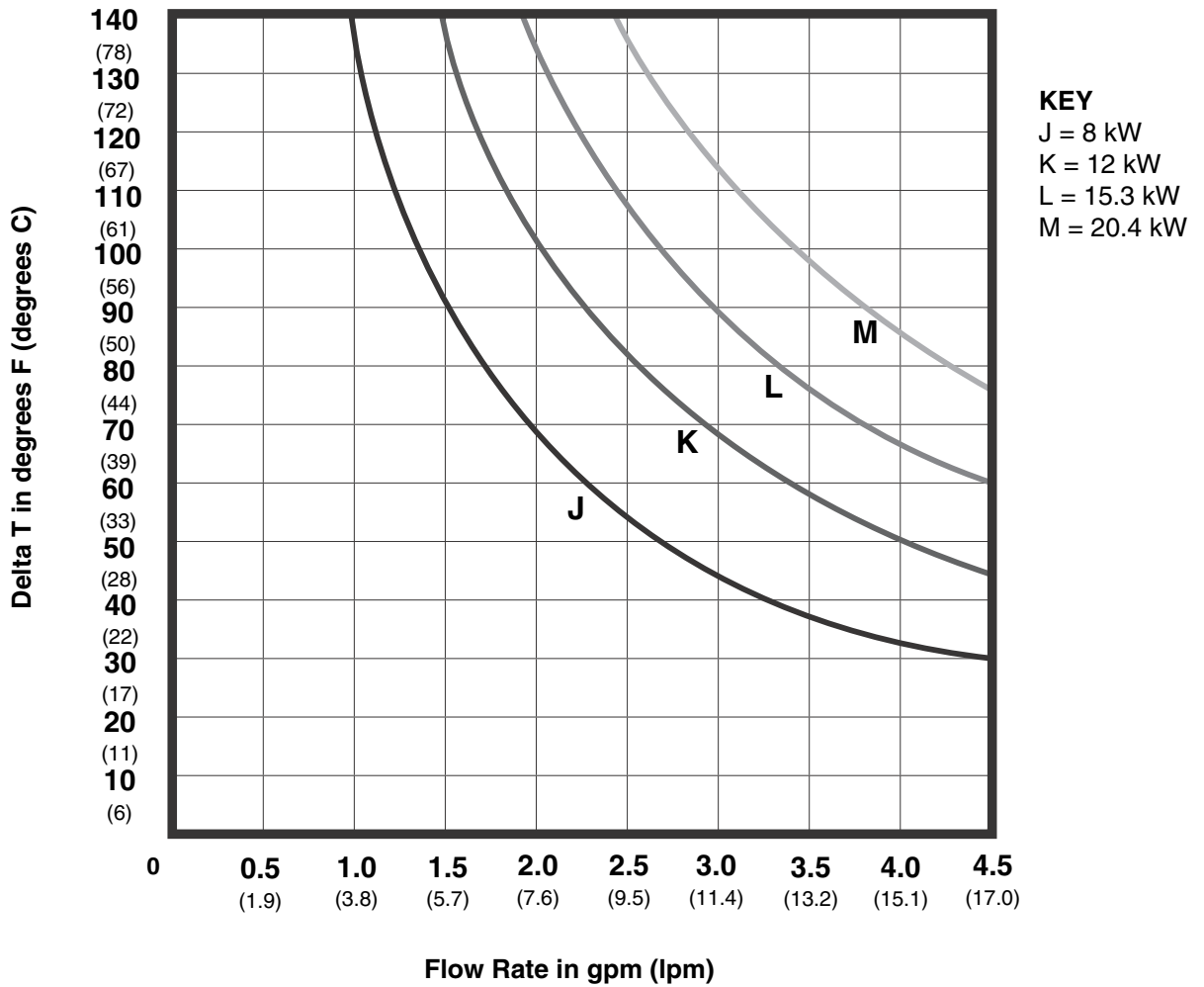

# Graco Standard Warranty

Graco warrants all equipment referenced in this document which is manufactured by Graco and bearing its name to be free from defects in material and workmanship on the date of sale to the original purchaser for use. With the exception of any special, extended, or limited warranty published by Graco, Graco will, for a period of twelve months from the date of sale, repair or replace any part of the equipment determined by Graco to be defective. This warranty applies only when the equipment is installed, operated and maintained in accordance with Graco's written recommendations.

This warranty does not cover, and Graco shall not be liable for general wear and tear, or any malfunction, damage or wear caused by faulty installation, misapplication, abrasion, corrosion, inadequate or improper maintenance, negligence, accident, tampering, or substitution of non-Graco component parts. Nor shall Graco be liable for malfunction, damage or wear caused by the incompatibility of Graco equipment with structures, accessories, equipment or materials not supplied by Graco, or the improper design, manufacture, installation, operation or maintenance of structures, accessories, equipment or materials not supplied by Graco.

This warranty is conditioned upon the prepaid return of the equipment claimed to be defective to an authorized Graco distributor for verification of the claimed defect. If the claimed defect is verified, Graco will repair or replace free of charge any defective parts. The equipment will be returned to the original purchaser transportation prepaid. If inspection of the equipment does not disclose any defect in material or workmanship, repairs will be made at a reasonable charge, which charges may include the costs of parts, labor, and transportation.

**THIS WARRANTY IS EXCLUSIVE, AND IS IN LIEU OF ANY OTHER WARRANTIES, EXPRESS OR IMPLIED, INCLUDING BUT NOT LIMITED TO WARRANTY OF MERCHANTABILITY OR WARRANTY OF FITNESS FOR A PARTICULAR PURPOSE.**

Graco's sole obligation and buyer's sole remedy for any breach of warranty shall be as set forth above. The buyer agrees that no other remedy (including, but not limited to, incidental or consequential damages for lost profits, lost sales, injury to person or property, or any other incidental or consequential loss) shall be available. Any action for breach of warranty must be brought within two (2) years of the date of sale.

**GRACO MAKES NO WARRANTY, AND DISCLAIMS ALL IMPLIED WARRANTIES OF MERCHANTABILITY AND FITNESS FOR A PARTICULAR PURPOSE, IN CONNECTION WITH ACCESSORIES, EQUIPMENT, MATERIALS OR COMPONENTS SOLD BUT NOT MANUFACTURED BY GRACO.** These items sold, but not manufactured by Graco (such as electric motors, switches, hose, etc.), are subject to the warranty, if any, of their manufacturer. Graco will provide purchaser with reasonable assistance in making any claim for breach of these warranties.

In no event will Graco be liable for indirect, incidental, special or consequential damages resulting from Graco supplying equipment hereunder, or the furnishing, performance, or use of any products or other goods sold hereto, whether due to a breach of contract, breach of warranty, the negligence of Graco, or otherwise.

## **FOR GRACO CANADA CUSTOMERS**

The Parties acknowledge that they have required that the present document, as well as all documents, notices and legal proceedings entered into, given or instituted pursuant hereto or relating directly or indirectly hereto, be drawn up in English. Les parties reconnaissent avoir convenu que la rédaction du présente document sera en Anglais, ainsi que tous documents, avis et procédures judiciaires exécutés, donnés ou intentés, à la suite de ou en rapport, directement ou indirectement, avec les procédures concernées.

# Graco Information

For the latest information about Graco products, visit [www.graco.com](http://www.graco.com).

**TO PLACE AN ORDER**, contact your Graco distributor or call to identify the nearest distributor.

**Phone:** 612-623-6921 **or Toll Free:** 1-800-328-0211 **Fax:** 612-378-3505

*All written and visual data contained in this document reflects the latest product information available at the time of publication.  
Graco reserves the right to make changes at any time without notice.*

This manual contains English. MM 312062

**Graco Headquarters:** Minneapolis

**International Offices:** Belgium, China, Japan, Korea

**GRACO INC. P.O. BOX 1441 MINNEAPOLIS, MN 55440-1441**

Copyright 2007, Graco Inc. is registered to ISO 9001

[www.graco.com](http://www.graco.com)

Revised 07/2009